

# 2021 FİYAT LİSTESİ

## KABLO KORUMA, TAŞIMA & SONLANDIRMA SİSTEMLERİ

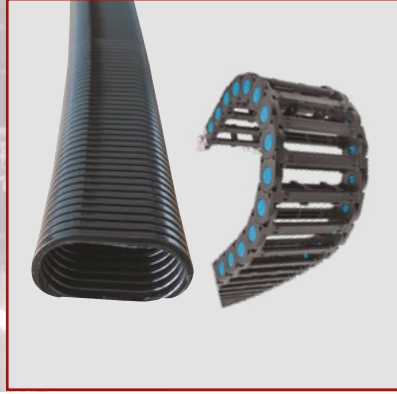

**ORTAC**<sup>®</sup>  
Cable Connection & Protection Systems

*güvenli bağlantılar kurar...*



Dünya'nın her noktasına, 100 den fazla ülkeye, 7 kıtaya ihracat gerçekleştiren Ortaç bugün kullandığı en üstün teknoloji ile yoluna emin adımlarla devam etmektedir.

Bugün 12.000 m<sup>2</sup> üretim tesisine sahip olan **Ortaç**; Türkiye'de ilk endüstriyel enjeksiyon makine kalıplarını üreten isimlerden biri olan Mehmet **Ortaç** tarafından 1969 yılında kurulmuştur.

Bugün **Ortaç**; farklı sanayiler ve pazarlar için plastik, metal kablo rakorları ve spiral boru ve aksesuarları üretilen mekanik, sistem mühendisliği, otomotiv sanayi, raylı sistemler, elektrik ve tesisat mühendisliği, tehlikeli alanlar, aydınlatma endüstrisi ve daha fazla alanlara hizmet eden dünya çapında bir kuruluştur.

Tüm **Ortaç** ürünleri firmanın İstanbul'daki kendi üretim tesislerinde; dizayn edilir, kalıplanır ve üretimi yapılır. **Ortaç** firması ve ürünleri şuan itibarıyla dünyanın farklı noktalarında 100'den fazla firma tarafından temsil edilmekte olup dünya çapında geniş iş ağıyla güçlü iş ilişkileri oluşturur.

**Ortaç**, uluslararası standartlar altında yoğun bir çalışma temposu, test süreçleri sayesinde tüm uluslararası standartlara sahip olup yüksek kalite konsepti, zaman yönetimi, iş etiği yaklaşımı ve uygun fiyat politikasını benimsemektedir. Böylece **Ortaç** dünyanın en önde gelen üreticilerinden birisi olarak öne çıkmıştır.





Kurumsal olarak başlıca hedef, tamamıyla kendi imalatı olan ürünleri ile firmanın üstün standartlarını dünyanın birçok noktasında duyurmayı hedef edinmekle birlikte, geniş ürün yelpazesinin sağladığı çeşitlilikten de güç alarak **Ortaç** standart ve kalitesine uygun şekilde mevcut güvenilir itibarını daha da yaymaktır.

Yalnız kablo rakorları değil ayrıca; bir çok farklı kullanım alanlarına hitap eden **Ortaç** ORvent havalandırma elemanları, Tacflex spiral boru ve ekipmanları, **Ortaç** hareketli kablo kanalları ve diğer **Ortaç** ürünleri ile **Ortaç** sektörünün en önde gelen firmalarından biri olmuştur.

Böylece firma “**Tedarikçiniz olmamızdan dolayı gurur duyuyoruz**” sloganını benimseyerek sektörde daha iyi olma prensibinin hatırlattığı yükümlülüklerini yerine getirme sorumluluğuyla dünyanın her noktasına ulaşmaya çalışır.

Öte yandan sosyal ve çevresel sorumluluklara uymak, finansal getirilerden öte prensiplerin şekillendirdiği **Ortaç** için bir zorunluluktur.

**Ortaç** müşterilerle yalnızca iş anlamında değil, ayrıca sosyal olarak ta samimi ilişkiler kurmayı ve daha uzun soluklu saygın ilişkileri tesis etmeyi benimser. Teknik departman olarak müşteriden gelen anlık taleplere bile gerekli bilgileri ve veri akışını sağlar.

**Ortaç**, bakış açısını müşterileri ve çalışanlarında gelen değerlendirmelere bağlı olarak doğru ilkeler ve problem çözücü adımlarla geniş çaplı hizmet skalasını geliştirmek olarak addeder. Araştırma ve geliştirme departmanı; dizayn, ekipmanlar, teknik özellikler ve müşterilerin taleplerine uygun teknik perspektiften ürün uygunluğunu sağlamak için adına çalışmalar yapar.



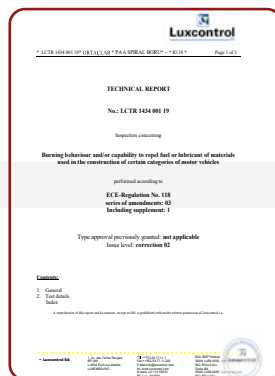
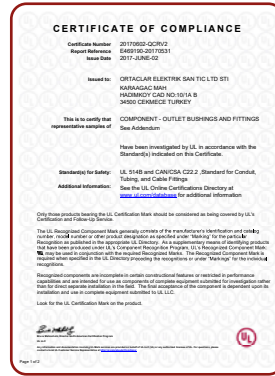

# KALİTE BELGELERİ



# INDEX

## KABLO RAKORLARI & AKSESUARLARI

POLYAMİDE KABLO RAKORLARI.....	7-8
TUBEGLAND, KÖRTAPA, TOZ TAPASI, SOMUNLAR.....	9
KAUÇUK KÖRTAPA, O-RİNG, RONDELA MULTİ CONTALAR.....	10
PRİNÇ KABLO RAKORLARI.....	11-14
PİRİNÇ KÖRTAPA, SOMUN, EMC SOMUNLAR.....	15
ORVENT HAVALANDIRMA TAPALARI & RAKORLARI .....	16-17

## EX-PROOF KABLO RAKORLARI & AKSESUARLARI

ATEX DIRECTIVE 94/9/EC .....	19
ATEX KODLAMA TABLOSU .....	20
ATEX KABLO RAKORLARI TEKNİK TABLO .....	21
KABLO RAKORLARI KOD AÇILIM TABLOSU .....	22
EXO SERİSİ POLYAMİDE EXPROOF ZIRHSIZ KABLO RAKORLARI .....	23
ZIRHSIZ KABLO RAKORLARI (MERAPİ UAG-UNZEN UG -STEX SERİSİ-EXMLS SERİSİ).....	24-25
ZIRHLI KABLO RAKORLARI (ETNA SERİSİ DCG - COLİMA SERİSİ ACG).....	26
UAGT SERİSİ EMC KABLO RAKORLARI, TOPRAKLAMA HALKASI - RAKOR KILIFI .....	27
EX-PROOF KÖRTAPALAR.....	28
EX-PROOF REDÜKSİYON, ADAPTÖR.....	29

## PANO MONTAJ EKİPMANLARI

SIRA KLEMENS, SOKET KLEMENS, PORSELEN KLEMENS, BUAT İÇİ KLEMENS.....	31
OPAK POLYESTER PANOLAR, PANO TİPİ DELİKLİ KABLO KANALLARI.....	32
MÜŞTEREK BARA SİSTEMLERİ, MONTAJ RAYLARI, KABLO ÇORAPLARI, HELEZON PANO SİRALLERİ.....	33
MOTOR KLEMENSLERİ, MOTOR PERVANELERİ, KLEMENS KUTULARI.....	34
İZOLATÖRLER .....	35
ISI İLE DARALAN MAKARONLAR (SİYAH - RENKLİ).....	36

## SİRAL BORULAR & AKSESUARLARI

POLYAMİDE PA6, POLİPROPOPİLEN PP SİRAL BORULAR, OVAL SİRAL BORULAR.....	38
GEÇMELİ TİP SİRAL RAKORLARI, KLİPSLER, Y-T DAĞITICILAR.....	39-41
İZOLELİ - İZOLESİZ GALVANİZ ÇELİK SİRALLER.....	42-43
YÜKSÜKLÜ TİP RAKORLAR, AĞIR HİZMET TİPİ SİRAL BORU RAKORLARI.....	44
ÇELİK SİRAL BORU RAKORLARI - POLYAMİD, ENTÜL, P KLİPS.....	45
HAREKETLİ KABLO TAŞIYICILARI .....	46-51

## EMT & IMC GALVANİZ BORULAR & AKSESUARLARI

EMT & IMC GALVANİZ BORULAR & AKSESUARLARI.....	52-55
YÜKSÜK-KABLO BAĞLARI-SKP'LER.....	56

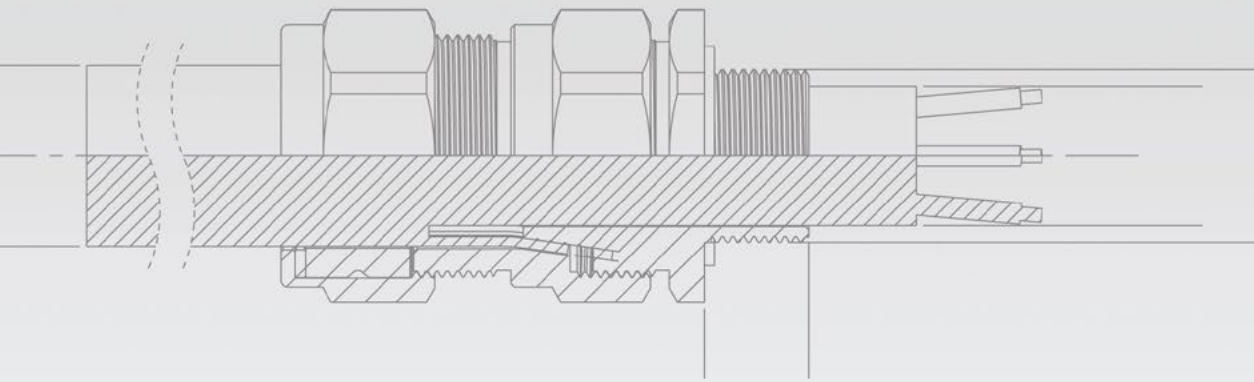

# We Establish Safety Connection In Hazardous Areas



## KABLO RAKORLARI & AKSESUARLARI

### STANDART ETANJ TİP KABLO RAKORLARI (Somunlu)

	Boy	Gri Kodu	Siyah Kodu	Montaj Çapı (mm)	Dış Uzunluğu (mm)	Sıkma Çapı (mm)	Koli Miktarı	Kutu Adeti	Birim Fiyatı TL
PG Serisi	PG 7	ORG 01	ORB 01	13	8	3-6,5	7200	400	<b>1,43</b>
	PG 9	ORG 02	ORB 02	16	8	4-8	5400	300	<b>1,60</b>
	PG 11	ORG 03	ORB 03	19	8	5-10	3600	200	<b>1,98</b>
	PG 13,5	ORG 04	ORB 04	21	9	6-12	2700	150	<b>2,17</b>
	PG 16	ORG 05	ORB 05	23	9	10-14	2250	125	<b>2,61</b>
	PG 21	ORG 06	ORB 06	29	11	13-18	1350	75	<b>3,88</b>
	PG 29	ORG 07	ORB 07	37,5	11	18-25	300	30	<b>7,06</b>
	PG 36	ORG 08	ORB 08	47,5	13	22-32	360	20	<b>12,05</b>
	PG 42	ORG 09	ORB 09	54,5	13	30-38	270	15	<b>15,82</b>
	PG 48	ORG 10	ORB 10	60	14	34-44	144	8	<b>17,82</b>
Metrik Serisi	M 12	OMRG 01	OMRB 01	12,5	8	3-6,5	7200	400	<b>1,47</b>
	M 16 K	OMRG 02	OMRB 02	16,5	8	4-8	5400	300	<b>1,77</b>
	M 16	OMRG 03	OMRB 03	16,5	10	5-10	3600	200	<b>2,00</b>
	M 20 K	OMRG 04	OMRB 04	20,5	10	6-12	2700	150	<b>2,32</b>
	M 20	OMRG 05	OMRB 05	20,5	10	10-14	2250	125	<b>2,67</b>
	M 25	OMRG 06	OMRB 06	25,5	10	13-18	1350	75	<b>3,98</b>
	M 32	OMRG 07	OMRB 07	32,5	10	18-25	720	40	<b>8,36</b>
	M 40	OMRG 08	OMRB 08	40,5	10	22-32	360	20	<b>13,60</b>
	M 50	OMRG 09	OMRB 09	50,5	18	30-38	270	15	<b>17,42</b>
	M 63	OMRG 10	OMRB 10	63,5	18	34-44	144	8	<b>22,53</b>



Klik Sistem  
Halogen Free

### KAPALI CONTALI ETANJ TİP KABLO RAKORLARI (Somunlu)

									Birim Fiyatı TL
PG Serisi	PG 7	KRG 01	KRB 01	13	8	3-6,5	-	400	<b>1,83</b>
	PG 9	KRG 02	KRB 02	16	8	4-8	-	300	<b>2,04</b>
	PG 11	KRG 03	KRB 03	19	8	5-10	-	200	<b>2,46</b>
	PG 13,5	KRG 04	KRB 04	21	9	6-12	-	150	<b>2,74</b>
	PG 16	KRG 05	KRB 05	23	9	10-14	-	125	<b>3,29</b>
	PG 21	KRG 06	KRB 06	29	11	13-18	-	75	<b>4,95</b>
	PG 29	KRG 07	KRB 07	37,5	11	18-25	-	30	<b>8,95</b>
	PG 36	KRG 08	KRB 08	47,5	13	22-32	-	20	<b>15,25</b>
	PG 42	KRG 09	KRB 09	54,5	13	30-38	-	15	<b>19,99</b>
	PG 48	KRG 10	KRB 10	60	14	34-44	-	8	<b>22,49</b>
Metrik Serisi	M 12	KMRG 01	KMRB 01	12,5	8	3-6,5	-	400	<b>1,87</b>
	M 16 K	KMRG 02	KMRB 02	16,5	8	4-8	-	300	<b>2,21</b>
	M 16	KMRG 03	KMRB 03	16,5	10	5-10	-	200	<b>2,55</b>
	M 20 K	KMRG 04	KMRB 04	20,5	10	6-12	-	150	<b>2,95</b>
	M 20	KMRG 05	KMRB 05	20,5	10	10-14	-	125	<b>3,41</b>
	M 25	KMRG 06	KMRB 06	25,5	10	13-18	-	75	<b>5,01</b>
	M 32	KMRG 07	KMRB 07	32,5	10	18-25	-	30	<b>10,57</b>
	M 40	KMRG 08	KMRB 08	40,5	10	22-32	-	20	<b>17,23</b>
	M 50	KMRG 09	KMRB 09	50,5	18	30-38	-	15	<b>22,03</b>
	M 63	KMRG 10	KMRB 10	63,5	18	34-44	-	8	<b>28,52</b>



•Toz Geçirmez

### UZUN DİŞ ETANJ TİP KABLO RAKORLARI (Somunlu)

									Birim Fiyatı TL
PG Serisi	PG 7	ORGL 01	ORBL 01	13	15	3-6,5	-	400	<b>2,00</b>
	PG 9	ORGL 02	ORBL 02	16	15	4-8	-	250	<b>2,21</b>
	PG 11	ORGL 03	ORBL 03	19	15	5-10	-	200	<b>2,67</b>
	PG 13,5	ORGL 04	ORBL 04	21	15	6-12	-	150	<b>2,97</b>
	PG 16	ORGL 05	ORBL 05	23	15	10-14	-	125	<b>3,60</b>
	PG 21	ORGL 06	ORBL 06	29	15	13-18	-	75	<b>5,35</b>
Metrik Serisi	M 12	OMRG 01 L	OMRB 01 L	12,5	15	3-6,5	-	400	<b>2,04</b>
	M 16 K	OMRG 11 S	OMRB 11 S	16,5	15	4-8	-	250	<b>2,38</b>
	M 16	OMRG 11	OMRB 11	16,5	15	5-10	-	200	<b>2,74</b>
	M 20 K	OMRG 12	OMRB 12	20,5	15	6-12	-	150	<b>3,18</b>
	M 20	OMRG 13	OMRB 13	20,5	15	10-14	-	125	<b>3,69</b>
	M 25	OMRG 14	OMRB 14	25,5	15	13-18	-	75	<b>5,45</b>
M 32	OMRG 15	OMRB 15	35,5	18	18-25	-	30	<b>11,48</b>	
M 40	OMRG 16	OMRB 16	40,5	18	22-32	-	20	<b>19,59</b>	



## KABLO RAKORLARI & AKSESUARLARI

### SPIRAL UÇLU ETANJ TİP KABLO RAKORLARI (Somunlu)



	Boy	Gri Kodu	Siyah Kodu	Kutu Adedi	Montaj Çap/mm	Diş Uzunluğu mm	Sıkma Çapı mm	Birim Fiyatı TL
<b>PG Serisi</b>	PG 7	ORG 19	ORB 19	200	13	8	3-6,5	<b>3,45</b>
	PG 9	ORG 20	ORB 20	150	16	8	4-8	<b>3,64</b>
	PG 11	ORG 21	ORB 21	100	19	8	5-10	<b>4,51</b>
	PG 13,5	ORG 22	ORB 22	75	21	9	6-12	<b>4,99</b>
	PG 16	ORG 23	ORB 23	50	23	9	10-14	<b>6,36</b>
	PG 21	ORG 24	ORB 24	30	29	11	13-18	<b>9,50</b>
<b>Metrik Serisi</b>	M 12	OMRG 17	OMRB 17	200	12,5	8	3-6,5	<b>3,45</b>
	M 16 K	OMRG 18	OMRB 18	150	16,5	8	4-8	<b>3,64</b>
	M 16	OMRG 19	OMRB 19	100	16,5	10	5-10	<b>4,51</b>
	M 20 K	OMRG 20	OMRB 20	75	20,5	10	6-12	<b>4,99</b>
	M 20	OMRG 21	OMRB 21	50	20,5	10	10-14	<b>6,36</b>
	M 25	OMRG 22	OMRB 22	30	25,5	10	13-18	<b>9,50</b>

### EUROMETRİK ETANJ TİP KABLO RAKORLARI (Somunlu) ÖZEL



								Birim Fiyatı TL
<b>Özel Çap</b>	M 25	OMRG E6	OMRB E6	75	25,5	10	11-17	<b>5,22</b>
	M 32	OMRG E7	OMRB E7	40	32,5	10	15-21	<b>10,99</b>
	M 40	OMRG E8	OMRB E8	20	40,5	10	19-28	<b>17,92</b>
<b>Uzun Diş</b>	M 25	OMRG E14	OMRB E14	75	25,5	15	11-17	<b>7,18</b>
	M 32	OMRG E15	OMRB E15	40	32,5	15	15-21	<b>15,14</b>
	M 40	OMRG E16	OMRB E16	20	40,5	15	19-28	<b>24,60</b>

### SR TİP ETANJ KABLO RAKORLARI (Somunlu)



Soketli Kablolara İçin

								Birim Fiyatı TL
	PG 21	ORG 06-SR05	ORB 06-SR05	75	29	11	5	<b>11,37</b>
	PG 21	ORG 06-2SR05	ORB 06-2SR05	75	29	11	2x5	<b>13,08</b>
	M 25	OMRG 06-SR05	OMRB 06-SR05	75	25,5	10	5	<b>11,37</b>
	M 25	OMRG 06-2SR05	OMRB 06-2SR05	75	25,5	10	2x5	<b>13,08</b>

### ES SERİSİ ETANJ TİP REDÜKSİYONLU KABLO RAKORLARI (Somunlu)



								Birim Fiyatı TL
	M 25	OMRG ES4	OMRB ES4	75	25,5	10	4-10	<b>9,90</b>
	M 25	OMRG ES6	OMRB ES6	75	25,5	10	6-12	<b>9,90</b>

### DÜZ TİP KABLO RAKORLARI (Somunlu)



								Birim Fiyatı TL
	PG 7	ORL 11		400	13	8	3,5-6	<b>1,56</b>
	PG 9	ORL 12		300	16	8	4,5-7	<b>1,73</b>
	PG 11	ORL 13		200	19	8	6-9	<b>2,13</b>
	PG 13,5	ORL 14		150	21	9	9-12	<b>2,34</b>
	PG 16	ORL 15		125	23	9	11-14	<b>2,82</b>
	PG 21	ORL 16		75	29	11	14-18	<b>4,19</b>
	PG29	ORL 17		30	37,5	11	18-25	<b>7,79</b>
	PG 36	ORL 18		20	47,5	13	25-32	<b>12,99</b>

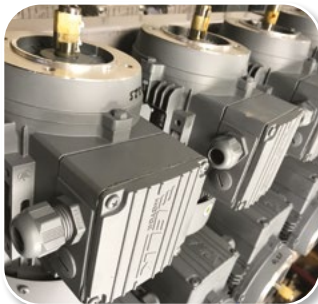



## KABLO RAKORLARI & AKSESUARLARI

### TUBEGLAND BAĞLANTI KONNEKTÖRÜ

Boy	Siyah Kodu	Sıkma Aralığı		Kutu Adedi	Birim Fiyatı (Seperatörlü) TL	Birim Fiyatı (Klemensli) TL
		A	B			
M 25 x 1,5	OTG 01	11-17	11-17	100	29,65	37,38
M 25 x 1,5	OTG 03	11-17	11-17	100	29,65	37,38
M 25 x 1,5	OTG 06	9-14	9-14	100	29,65	37,38
M 25 x 1,5	OTG 09	9-14	6-12	100	29,65	37,38



AYDINLATMA UYGULAMALARINDA HIZLI, PRATİK, GÜVENLİ  
**KABLO BİRLEŞTİRME KONNEKTÖRÜ**

### POLYAMİD KÖRTAPA

	Boy	Gri Kodu	Siyah Kodu	Kutu Adedi	Montaj Çap/mm	Birim Fiyatı TL
PG Serisi	PG 7	OGK 01	OBK 01	100	13	0,84
	PG 9	OGK 02	OBK 02	100	16	0,93
	PG 11	OGK 03	OBK 03	100	19	0,97
	PG 13,5	OGK 04	OBK 04	100	21	1,20
	PG 16	OGK 05	OBK 05	100	23	1,54
	PG 21	OGK 06	OBK 06	50	29	1,83
	PG 29	OGK 07	OBK 07	25	37,5	3,07
	PG 36	OGK 08	OBK 08	25	47,5	4,44
Metrik Serisi	M 12	MOGK 01	MOBK 01	100	12,5	0,93
	M 16	MOGK 02	MOBK 02	100	16,5	0,97
	M 20	MOGK 03	MOBK 03	100	20,5	1,37
	M 25	MOGK 04	MOBK 04	50	25,5	1,77
	M 32	MOGK 05	MOBK 05	25	32,5	2,04
	M 40	MOGK 06	MOBK 06	25	40,5	4,55



### POLYAMİD SOMUN (Cam Elyaf Katkılı)

	Boy	Gri Kodu	Siyah Kodu	Kutu Adedi	Ø	Birim Fiyatı TL
PG Serisi	PG 7	OSG 01	OSB 01	100	19	0,57
	PG 9	OSG 02	OSB 02	100	22	0,57
	PG 11	OSG 03	OSB 03	100	24	0,61
	PG 13,5	OSG 04	OSB 04	100	27	0,74
	PG 16	OSG 05	OSB 05	100	30	0,78
	PG 21	OSG 06	OSB 06	50	36	1,24
	PG 29	OSG 07	OSB 07	25	46	2,27
	PG 36	OSG 08	OSB 08	25	60	3,69
	PG 42	OSG 09	OSB 09	10	65	4,44
	PG 48	OSG 10	OSB 10	10	70	6,59
Metrik Serisi	M 12	MSG 01	MSB 01	100	18	0,61
	M 16	MSG 02	MSB 02	100	22	0,84
	M 20	MSG 03	MSB 03	100	26	1,24
	M 25	MSG 04	MSB 04	50	32	1,37
	M 32	MSG 05	MSB 05	25	41	2,27
	M 40	MSG 06	MSB 06	25	50	4,09
	M 50	MSG 07	MSB 07	10	60	6,19
	M 63	MSG 08	MSB 08	10	75	9,27



### ETANJ RAKOR TAPALARI

Boy	Kod	Birim Fiyatı TL
PG 7 M 12	PTB 01	0,34
PG 9 M 16	PTB 02	0,36
PG 11 M 16	PTB 03	0,44
PG 13 M 20	PTB 04	0,53
PG 16 M 20	PTB 05	0,57
PG 21 M 25	PTB 06	0,86
PG 29 M 32	PTB 07	1,03
PG 36 M 40	PTB 08	1,35
PG 42 M 50	PTB 09	1,54
PG 48 M 63	PTB 10	2,06



Toz Önleyici Tapa



## KABLO RAKORLARI & AKSESUARLARI

### KAUÇUK KÖRTAPA / AÇIK GRİ - SİYAH



A. Gri Kod	Siyah Kod	Boy	Montaj Çapı / mm.	Kutu Adedi	Birim Fiyatı A. Gri /Siyah TL
OKKG 01	OKKB 01	PG 13,5	17	100	1,36
OKKG 02	OKKB 02	PG 16	22,8	100	1,36
OKKG 02D	OKKB 02D	PG 16	22,8	100	1,36
OKKG 03	OKKB 03	PG 21	28,6	100	1,68
OKKG 04	OKKB 04	PG 29	37,3	100	2,04
OKKG 05	OKKB 05	PG 36	47	50	4,35
OKKG 06	OKKB 06	PG 42	55	50	8,89

### KABLO RAKORU O-RİNGİ



Kod	Boy	Et Kalınlık	Birim Fiyatı TL
90015	PG7/M12	1,5	0,082
11015	PG9/M16	1,5	0,112
13015	PG11	1,5	0,127
16015	PG13,5/M20	1,5	0,238
18015	PG16	1,5	0,262
19020	M25	2	0,262
22020	PG21/M32	2	0,314
30020	PG29/M40	2	0,722
40020	PG36/M50	2	1,133
48020	PG42	2	1,557
53020	PG48/63	2	1,719

### KABLO RAKORU YASSI RONDELA



PG Kod	PG Ölçü	Metrik Kod	Metrik Ölçü	Et Kalınlık	Birim Fiyatı TL
ZZ/RON01TP	PG7	RN-TP-M12	M12	1,4	0,510
ZZ/RON02TP	PG9	RN-TP-M16K	M16	1,5	0,650
ZZ/RON03TP	PG11	RN-TP-M16	M16	1,5	0,680
ZZ/RON04TP	PG13,5	RN-TP-M20K	M20	1,5	0,680
ZZ/RON05TP	PG16	RN-TP-M20	M20	1,5	0,720
ZZ/RON06TP	PG21	RN-TP-M25	M25	1,5	0,770
ZZ/RON07TP	PG29	RN-TP-M32	M32	2	1,450
ZZ/RON08TP	PG36	RN-TP-M40	M40	2	1,480
ZZ/RON09TP	PG42	RN-TP-M50	M50	2	1,640
ZZ/RON10TP	PG48	RN-TP-M63	M63	2	1,870

### ÇOK DELİKLİ MULTİ CONTALAR



Kod	Plastik Boy	Delik Adedi	Ölçü mm	Kutu Adedi	Metal Boy	Birim Fiyatı TL
MEC02A3	PG9/M16K	2	3	20	PG9/M16	2,31
MEC03A3	PG9/M16K	3	3	20	PG9/M16	2,31
MEC02C3	PG9/M16K	4	3	20	PG9/M16	2,31
MEC03A4	PG11/M16	2	4	20	PG11	2,75
MEC03A5	PG11/M16	2	5	20	PG11/M20	2,75
MEC03B5	PG11/M16	3	5	20	PG11/M20	2,75
MEC04A6	PG11/M16	2	6	20	PG13,5	3,02
MEC04B5	PG13,5/M20K	3	5	20	PG13,5	3,02
MEC05A4	PG13,5/M20K	2	4	20	PG16/M25	3,66
MEC05A7	PG16/M20	2	7	20	PG16/M25	3,66
MEC05B6	PG16/M20	3	6	20	PG16/M25	3,66
MEC05C5	PG16/M20	4	5	20	PG16/M25	3,66
MEC06A9	PG16/M20	2	9	20	PG21/M32	5,44
MEC06B7	PG21/M25	3	7	20	PG21/M32	5,44
MEC06B8	PG21/M25	3	8	20	PG21/M32	5,44
MEC06C7	PG21/M25	4	7	20	PG21/M32	5,44
MEC06G4	PG21/M25	8	4	20	PG21/M32	5,44
MEC07C9	PG29/M32	4	9	20	OG29/M40	18,58
MEC07D3	PG29/M32	16	3	20	OG29/M40	18,58
MEC08E8	PG36/M40	6	8	20	OG29/M40	18,58

## KABLO RAKORLARI & AKSESUARLARI

### PİRİNÇ NİKEL KAPLI KABLO RAKORLARI (Somunlu)

	Boy	Kod	Kutu Adedi	Montaj Çap/mm	Dış Uzunluğu mm	Sıkma Çapı mm	Birim Fiyatı TL
<b>PG Serisi</b>	PG 7	OPBG 01	100	13	6	3-6,5	<b>9,95</b>
	PG 9	OPBG 02	50	16	6	4-8	<b>13,10</b>
	PG 11	OPBG 03	50	19	6	5-10	<b>14,35</b>
	PG 13,5	OPBG 04	50	21	6,5	6-12	<b>16,42</b>
	PG 16	OPBG 05	50	23	6,5	10-14	<b>18,92</b>
	PG 21	OPBG 06	25	29	7	13-18	<b>32,28</b>
	PG 29	OPBG 07	20	37,5	8	18-25	<b>58,33</b>
	PG 36	OPBG 08	10	47,5	10	22-32	<b>98,50</b>
	PG 42	OPBG 09	5	54,5	12	30-38	<b>122,56</b>
	PG 48	OPBG 10	5	60	14	33-44	<b>165,17</b>
<b>Metrik Serisi</b>	M 12	OMBG 01	100	12,5	6	3-6,5	<b>10,04</b>
	M 16	OMBG 02	50	16,5	7	4-8	<b>13,30</b>
	M 20	OMBG 03	50	20,5	8	6-12	<b>18,09</b>
	M 25	OMBG 04	25	25,5	8	10-14	<b>22,81</b>
	M 25	OMBG 04/06	25	25,5	8	13-18	<b>38,19</b>
	M 32	OMBG 05	20	32,5	9	13-18	<b>75,89</b>
	M 40	OMBG 06	10	40,5	9	18-25	<b>128,01</b>
	M 50	OMBG 07	5	50,5	9	22-32	<b>194,29</b>
	M 63	OMBG 08	5	63,5	14	33-44	<b>286,28</b>
	M 63B	OMBG 17	5	63,5	15	44-55	<b>404,84</b>
	M 72	OMBG 17s	5	72,5	20	45-55	<b>419,90</b>
	M 75	OMBG 18	5	76	20	50-63	<b>522,04</b>
	M 80	OMBG 18-80	5	80,5	20	50-63	<b>522,04</b>
M 90	OMBG 19	5	90	20	60-70	<b>802,63</b>	



• M63 - M90

### PİRİNÇ NİKEL KAPLI KABLO RAKORLARI (Somunlu) UZUN DİŞ

	Boy	Kod	Kutu Adedi	Montaj Çap/mm	Dış Uzunluğu mm	Sıkma Çapı mm	Birim Fiyatı TL
<b>PG Serisi</b>	PG 7	OPBG 11	50	13	10	3-6,5	<b>13,44</b>
	PG 9	OPBG 12	50	16	10	4-8	<b>17,94</b>
	PG 11	OPBG 13	50	19	10	5-10	<b>19,33</b>
	PG 13,5	OPBG 14	50	21	10	6-12	<b>22,13</b>
	PG 16	OPBG 15	50	23	10	10-14	<b>25,50</b>
	PG 21	OPBG 16	50	29	12	13-18	<b>43,53</b>
	PG 29	OPBG 17	20	37,5	12	18-25	<b>78,64</b>
	PG 36	OPBG 18	15	47,5	14	22-32	<b>132,78</b>
	PG 42	OPBG 19	10	54,5	18	30-38	<b>165,22</b>
	PG 48	OPBG 20	5	60	18	33-44	<b>216,53</b>
<b>Metrik Serisi</b>	M 12	OMBG 09	50	12,5	12	3-6,5	<b>13,54</b>
	M 16	OMBG 10	50	16,5	12	4-8	<b>17,99</b>
	M 20	OMBG 11	50	20,5	12	6-12	<b>24,39</b>
	M 25	OMBG 12	50	25,5	12	10-14	<b>30,75</b>
	M 32	OMBG 13	20	32,5	14	13-18	<b>51,49</b>
	M 40	OMBG 14	15	40,5	14	18-25	<b>102,31</b>
	M 50	OMBG 15	10	50,5	14	22-32	<b>172,57</b>
M 63	OMBG 16	5	63,5	18	33-44	<b>256,93</b>	



### MINI GLAND PİRİNÇ NİKEL KAPLI KABLO RAKORLARI (Somunlu) KISA TİP

	Boy	Kod	Kutu Adedi	Montaj Çap/mm	Dış Uzunluğu mm	Sıkma Çapı mm	Birim Fiyatı TL
<b>PG Serisi</b>	PG7	MGP7-24	-	13	6	2-4	<b>15,5</b>
	PG7	MGP7-35	-	13	6	3-5	<b>15,5</b>
	PG7	MGP7-68	-	13	6	3-5	<b>18,04</b>
	PG9	MGP9-46	-	16	6	4-6	<b>18,04</b>
	PG9	MGP9-68	-	16	6	6-8	<b>18,04</b>
<b>Metrik Serisi</b>	M8	MGM8s-35	-	8,5	6	3-5	<b>15,5</b>
	M8	MGM8- 24	-	8,5	6	2-4	<b>15,5</b>
	M10	MGM10s- 46	-	10,5	6	4-6	<b>15,5</b>
	M10	MGM10- 24	-	10,5	6	2-4	<b>15,5</b>
	M10	MGM10- 36	-	10,5	6	3-6	<b>15,5</b>
	M12	MGM12- 24	-	12,5	6	2-4	<b>15,5</b>
	M12	MGM12- 36	-	12,5	6	3-6	<b>15,5</b>

STANDART RAKOR  
M12 X 1,5

MINI RAKOR  
M12 X 1,5



\* Kablo ve montaj çaplarına göre özel boy üretilmektedir.



## KABLO RAKORLARI & AKSESUARLARI

### PASLANMAZ ÇELİK KABLO RAKORLARI (Somunlu) AISI 303



	Boy	Kod	Kutu Adedi	Montaj Çap/mm	Diş Uzunluğu mm	Sıkma Çapı mm	Birim Fiyatı TL
PG Serisi	PG 7	OPSG 01	100	13	6	3-6,5	112,61
	PG 9	OPSG 02	50	16	6	4-8	123,23
	PG 11	OPSG 03	50	19	6	5-10	140,32
	PG 13,5	OPSG 04	50	21	6,5	6-12	143,21
	PG 16	OPSG 05	50	23	6,5	10-14	160,23
	PG 21	OPSG 06	25	29	7	13-18	253,35
	PG 29	OPSG 07	20	37,5	8	18-25	391,42
	PG 36	OPSG 08	10	47,5	10	22-32	687,80
	PG 42	OPSG 09	5	54,5	12	30-38	1.043,90
	PG 48	OPSG 10	5	60	14	33-44	1.239,12
Metrik Serisi	M 12	OMSG 01	100	12,5	6	3-6,5	112,39
	M 16	OMSG 02	50	16,5	7	4-8	126,19
	M 20	OMSG 03	50	20,5	8	6-12	145,14
	M 25	OMSG 04	25	25,5	8	10-14	212,25
	M 25	OMSG 04/06	25	25,5	8	13-18	219,95
	M 32	OMSG 05	20	32,5	9	13-18	292,52
	M 40	OMSG 06	15	40,5	9	18-25	520,50
	M 50	OMSG 07	5	50,5	9	22-32	724,72
M 63	OMSG 08	5	63,5	14	33-44	1.296,28	

### SPIRAL UÇLU PİRİNÇ NİKEL KAPLI KABLO RAKORLARI (Somunsuz)



	Boy	Kod	Kutu Adedi	Montaj Çap/mm	Diş Uzunluğu mm	Sıkma Çapı mm	Birim Fiyatı TL
PG Serisi	PG 7	STPG 01	100	13	6	3-6,5	44,93
	PG 9	STPG 02	50	16	6	4-8	53,25
	PG 11	STPG 03	50	19	6	5-10	61,61
	PG 13,5	STPG 04	50	21	6,5	6-12	75,82
	PG 16	STPG 05	50	23	6,5	10-14	81,35
	PG 21	STPG 06	25	29	7	13-18	98,75
Metrik Serisi	M 12	STCG 01	100	12,5	6	3-6,5	45,07
	M 16	STCG 02	50	16,5	7	4-8	54,00
	M 20	STCG 03	50	20,5	8	6-12	77,74
	M 25	STCG 04	50	25,5	8	10-14	82,59
	M 32	STCG 05	25	32,5	9	13-18	100,26

### EMC TİP TOPRAKLAMALI PİRİNÇ NİKEL KAPLI KABLO RAKORLARI (Somunsuz)



	Boy	Kod	Kutu Adedi	Montaj Çap/mm	Diş Uzunluğu mm	Sıkma Çapı mm	Birim Fiyatı Euro
PG Serisi	PG 7	OPBT 01	100	13	6	3-6,5	2,31
	PG 9	OPBT 02	50	16	6	4-8	2,42
	PG 11	OPBT 03	50	19	6	5-10	2,60
	PG 13,5	OPBT 04	50	21	6,5	6-12	2,90
	PG 16	OPBT 05	50	23	6,5	10-14	3,25
	PG 21	OPBT 06	25	29	7	13-18	4,73
	PG 29	OPBT 07	20	37,5	8	18-25	8,43
	PG 36	OPBT 08	10	47,5	10	22-32	14,65
	PG 42	OPBT 09	5	54,5	12	30-38	18,01
	PG 48	OPBT 10	5	60	14	33-44	23,33
Metrik Serisi	M 12	OMBT 01	100	12,5	6	3-6,5	1,95
	M 16	OMBT 02	50	16,5	7	4-8	2,05
	M 20	OMBT 03	50	20,5	8	6-12	2,85
	M 25	OMBT 04	25	25,5	8	10-14	3,74
	M 32	OMBT 05	20	32,5	9	13-18	6,10
	M 40	OMBT 06	10	40,5	9	18-25	9,40
	M 50	OMBT 07	5	50,5	9	22-32	17,36
	M 63	OMBT 08	5	63,5	14	33-44	24,71

- Elektromanyetik oluşumu engeller
- Ekranlı kablolarda kullanılır
- 360°C ekran tutma özelliği



## KABLO RAKORLARI & AKSESUARLARI

### NPT DİŞ PRİNÇ NİKEL KAPLI KABLO RAKORLARI (Somunsuz)

Boy	Kod	Dış Uzunluğu mm	Sıkma Çapı	Birim Fiyatı TL
1/4"	ONBG 01	11,5	3 - 6,5	17,17
3/8"	ONBG 02	11,5	4-8	21,40
1/2"	ONBG 03	13	6-12	30,09
3/4"	ONBG 04	13	10-14	39,36
1"	ONBG 05	13	13 - 18	59,50
1 1/4"	ONBG 06	15	18 - 25	107,88
1 1/2"	ONBG 07	15	22 - 32	143,92
2"	ONBG 08	15	33 - 44	245,75
2"	ONBG 09	15	45 - 50	310,43
2 1/2"	ONBG 18	20	50 - 63	423,63
3"	ONBG 19s	24	50 - 63	596,46
3"	ONBG 19	24	60 - 70	786,91



### ÖZEL KABLO ÇAPLI PİRİNÇ NİKEL KAPLI KABLO RAKORLARI (Somunlu)

Boy	Kod	Montaj Çapı	Dış Uzunluğu mm	Sıkma Çapı	Birim Fiyatı
PG 7	OPBG 01/02	13	6	4-8	
PG 9	OPBG 02/03	16	6	5-10	
PG 9	OPBG 02/04	16	6	6-12	
PG 11	OPBG 03/04	19	6	6-12	
PG 11	OPBG 03/05	19	6	10-14	
PG 13,5	OPBG 04/05	21	6,5	10-14	
PG 16	OPBG 05/06	23	6,5	13 - 18	
PG 21	OPBG 06RS	29	7	9-17	
PG 29	OPBG 07/08	37,5	8	22 - 32	
PG 36	OPBG 08/09	47,5	10	30 - 38	
PG 42	OPBG 09/10	54,5	12	33 - 44	
M 12	OMBG 01/02	12,5	6	4-8	
M 16	OMBG 02/03	16,5	7	5-10	
M 16	OMBG 02/04	16,5	7	6-12	
M 20	OMBG 03/05	20,5	8	10-14	
M 25	OMBG 04/04	25,5	8	6-12	
M 25	OMBG 04ES	25,5	8	9-17	
M 25	OMBG 04/06	25,5	8	13 - 18	
M 32	OMBG 05/07	32,5	9	18 - 25	
M 40	OMBG 06/08	40,5	9	22 - 32	
M 50	OMBG 07/09	50,5	9	30 - 38	
M 50	OMBG 07/10	50,5	9	33 - 44	

PG Serisi

Metrik Serisi



• Özel kablo çaplı model

### VG NORM TOPRAKLAMALI PRİNÇ NOZUL RAKOR (GEMİ TİPİ)

Boy	Kod	Ø mm	Dış Uzunluğu mm	Sıkma Çapı	Birim Fiyatı
M16x1,5	MACG16A	20	9	10,5	
M18x1,5	MACG18A	22	10	11,5	
M18x1,5	MACG18B	22	10	11,5-12,5	
M24x1,5	MACG24A	28	11	11,5	
M24x1,5	MACG24B	28	11	11,5-13,5	
M24x1,5	MACG24C	28	11	13,5-16,5	
M30x2,0	MACG30A	35	12	16,5-18	
M30x2,0	MACG30B	35	12	18-19,5	
M30x2,0	MACG30C	35	12	19,5-20,5	
M36x2,0	MACG36A	40	13	20,5-22,5	
M36x2,0	MACG36B	40	13	22,5-25,5	
M45x2,0	MACG45A	50	14	25,5-27,5	
M45x2,0	MACG45B	50	14	27,5-31,5	
M56x2,0	MACG56A	62	15	31,5-34	
M56x2,0	MACG56B	62	15	34-37,5	
M56x2,0	MACG56C	62	15	37,5-41	
M72x2,0	MACG72A	78	16	41-46	
M72x2,0	MACG72B	78	16	46-50,5	



## KABLO RAKORLARI & AKSESUARLARI

### PİRİNÇ NİKEL KAPLI KABLO RAKORLARI (Somunlu) ÖZEL UZUN DIŞ



	Boy	Kod	Kutu Adedi	Montaj Çap/mm	Diş Uzunluğu mm	Sıkma Çapı mm	Birim Fiyatı TL
<b>PG Serisi</b>	PG 7	OPBGL 01	50	13	25	3-6,5	<b>27,39</b>
	PG 9	OPBGL 02	50	16	25	4-8	<b>34,52</b>
	PG 11	OPBGL 03	50	19	25	5-10	<b>36,30</b>
	PG 13,5	OPBGL 04	50	21	25	6-12	<b>41,49</b>
	PG 16	OPBGL 05	50	23	25	10-14	<b>47,90</b>
	PG 21	OPBGL 06	50	29	25	13-18	<b>81,80</b>
	PG 29	OPBGL 07	20	37,5	25	18-25	<b>141,39</b>
<b>Metrik Serisi</b>	M 12	OMBGL 01	50	12,5	25	3-6,5	<b>27,84</b>
	M 16	OMBGL 02	50	16,5	25	4-8	<b>35,13</b>
	M 20	OMBGL 03	50	20,5	25	6-12	<b>43,83</b>
	M 25	OMBGL 04	50	25,5	25	10-14	<b>57,73</b>
	M 32	OMBGL 05	50	32,5	25	13-18	<b>97,04</b>
	M 40	OMBGL 06	15	40,5	25	18-25	<b>183,95</b>

### DÜZ / KELEPÇELİ TİP PİRİNÇ KABLO RAKORLARI (Somunlu)



	Boy	Düz Tip Kod	Kelepçeli Tip Kod	Kablo Çap/mm	Montaj Çap/mm	Düz Tip Birim Fiyatı TL	Kelepçeli Tip Birim Fiyatı TL
	PG 7	DOPR 01	OKPR 01	3-7	12,5	<b>16,70</b>	<b>38,53</b>
	PG 9	DOPR 02	OKPR 02	6-9	15,5	<b>20,55</b>	<b>41,10</b>
	PG 11	DOPR 03	OKPR 03	7-10	18,5	<b>25,69</b>	<b>46,24</b>
	PG 13,5	DOPR 04	OKPR 04	8-11	20,5	<b>28,26</b>	<b>51,38</b>
	PG 16	DOPR 05	OKPR 05	10-14	22,5	<b>30,83</b>	<b>56,51</b>
	PG 21	DOPR 06	OKPR 06	14-19	28,5	<b>51,38</b>	<b>77,06</b>
	PG Ø 25	DOPR Ø 25	OKPR Ø 25	18-24	32	<b>66,79</b>	<b>102,75</b>
	PG 29	DOPR 07	OKPR 07	23-28	37,5	<b>87,34</b>	<b>128,44</b>
	PG 36	DOPR 08	OKPR 08	28-34	47	<b>148,99</b>	<b>210,64</b>
	PG 42	DOPR 09	OKPR 09	35-41	55	<b>179,82</b>	<b>295,41</b>
	PG 48	DOPR 10	OKPR 10	38-44	60	<b>256,88</b>	<b>349,36</b>
	Ø 55	DOPR Ø 55	OKPR Ø 55	43-48	65	<b>281,13</b>	<b>362,65</b>
	Ø 60	DOPR Ø 60	OKPR Ø 60	47-54	70	<b>391,58</b>	<b>521,57</b>
	Ø 70	DOPR Ø 70	OKPR Ø 70	55-63	80	<b>522,43</b>	<b>612,42</b>
	Ø 80	DOPR Ø 80	OKPR Ø 80	64-72	90	<b>885,66</b>	<b>1.047,25</b>
	Ø 90	DOPR Ø 90	OKPR Ø 90	74-82	100	<b>1.506,02</b>	<b>1.873,05</b>

\* Nikel kaplamalı için %10 ilave edilir

### SR TİP PİRİNÇ NİKEL KAPLI KABLO RAKORLARI (Somunlu)



	Boy	Kod	Kutu Adedi	Montaj Çapı	Diş Uzunluğu / mm	Sıkma Çapı / mm	Birim Fiyatı TL
<b>PG Serisi</b>	PG 13,5	OPBG 04-SR5	25	21	6,5	5	<b>32,88</b>
	PG 16	OPBG 05-SR5	25	23	6,5	5	<b>35,01</b>
	PG 21	OPBG 06-SR5	25	29	7	5	<b>40,46</b>
	PG 21	OPBG 06-2SR5	25	29	7	2X5	<b>42,44</b>
<b>Metrik Serisi</b>	M 20	OMBG 03-SR5	25	20,5	8	5	<b>32,88</b>
	M 25	OMBG 04-SR5	25	25,5	8	5	<b>35,01</b>
	M 32	OMBG 06-SR5	25	32,5	9	5	<b>49,91</b>
	M 32	OMBG 06-2SR5	25	32,5	9	2X5	<b>52,42</b>

## KABLO RAKORLARI & AKSESUARLARI

### PİRİNÇ KÖRTAPA (Nikelli)

	Boy	Kod	Kutu Adedi	Montaj Çap/mm	Birim Fiyatı TL
PG Serisi	PG 7	OPBK 01	100	13	5,37
	PG 9	OPBK 02	50	16	6,36
	PG 11	OPBK 03	50	19	7,55
	PG 13,5	OPBK 04	50	21	8,76
	PG 16	OPBK 05	50	23	10,75
	PG 21	OPBK 06	25	29	16,04
	PG 29	OPBK 07	20	37,5	25,92
	PG 36	OPBK 08	10	47,5	46,23
	PG 42	OPBK 09	5	54,5	64,55
	PG 48	OPBK 10	5	60	77,67
Metrik Serisi	M 12	OMBK 01	100	12,5	4,95
	M 16	OMBK 02	50	16,5	6,42
	M 20	OMBK 03	50	20,5	8,88
	M 25	OMBK 04	25	25,5	13,83
	M 32	OMBK 05	20	32,5	20,93
	M 40	OMBK 06	10	40,5	32,12
	M 50	OMBK 07	5	50,5	52,75
	M 63	OMBK 08	5	63,5	80,88



### PİRİNÇ SOMUN (Nikelli)

	Boy	Kod	Kutu Adedi	Anahtar Ağız/mm	Birim Fiyatı TL
PG Serisi	PG 7	OPBL 01	100	15	1,77
	PG 9	OPBL 02	50	18	1,97
	PG 11	OPBL 03	50	21	2,22
	PG 13,5	OPBL 04	50	23	2,91
	PG 16	OPBL 05	50	26	3,03
	PG 21	OPBL 06	25	32	4,19
	PG 29	OPBL 07	20	40	6,58
	PG 36	OPBL 08	10	50	12,06
	PG 42	OPBL 09	5	60	20,99
	PG 48	OPBL 10	5	64	21,86
Metrik Serisi	M 12	OMBL 01	100	15	1,87
	M 16	OMBL 02	50	19	2,79
	M 20	OMBL 03	50	24	3,63
	M 25	OMBL 04	25	30	4,76
	M 32	OMBL 05	20	36	5,93
	M 40	OMBL 06	10	45	10,28
	M 50	OMBL 07	5	55	21,09
	M 63	OMBL 08	5	68	28,17



### PİRİNÇ EMC SOMUN (Nikelli)

	Boy	Kod	Kutu Adedi	Anahtar Ağız / mm	Birim Fiyatı Euro
PG Serisi	PG 7	OPBLT 01	100	15	0,35
	PG 9	OPBLT 02	50	18	0,40
	PG 11	OPBLT 03	50	21	0,43
	PG 13,5	OPBLT 04	50	23	0,48
	PG 16	OPBLT 05	50	26	0,61
	PG 21	OPBLT 06	25	32	0,78
	PG 29	OPBLT 07	20	40	1,06
	PG 36	OPBLT 08	10	50	1,64
	PG 42	OPBLT 09	5	60	2,50
	PG 48	OPBLT 10	5	65	3,00
Metrik Serisi	M 12	OMBLT 01	100	15	0,35
	M 16	OMBLT 02	50	19	0,43
	M 20	OMBLT 03	50	24	0,53
	M 25	OMBLT 04	50	30	0,71
	M 32	OMBLT 05	50	36	0,88
	M 40	OMBLT 06	25	45	1,34
	M 50	OMBLT 07	20	55	2,02
	M 63	OMBLT 08	5	70	3,81



- OMBT - OPBT - EMC Tip rakorlarda kullanılır.
- Sivri uç sayesinde topraklama imkanı sağlar





## Neden ORvent?

- ORTAC , ORvent ürün gurubu ile aydınlatma ,Solar,endüstriyel uygulamalar sektörlerindeki değişim ve gelişimi görüp bu sektördeki üreticilerin ihtiyaç duyduğu tamamlayıcı ürünlerin dünya standartlarında ve teknolojisinde üreterek dışa bağımlılıklarını ortadan kaldırarak üreticilerimizin dünya pazarındaki rekabet gücünü arttırmaktadır.
- ORTAC ORvent basınç dengeleme sistemleri havalandırma nem rakorları ve tapalarını ürün gamına eklemiştir. Dış mekan led armatürleri çevre şartlarına dayanıklı olması gerekmektedir. Çevre şartlarına karşı dayanıklılığını arttırmak için etkili bir çözümü ORvent ventil rakor ve tapalar sunmaktadır. ORvent ventil rakor ve tapalar suz ve toz geçirmez olup geçirdiği hava ile armatür kasasında oluşan basıncı dengeler armatürün ömrünü uzatır Kolay pratik ve ekonomik çözüm sunar.
- Harici ortam sıcaklıklarındaki yağmur,kar ve buna bağlı ani ısı değişimleri basınç farklılıklarına sebep olur.basınç farklılıklarına neden olan bir diğer etken ise led armatür veya elektrik bağlantı kutularının açılış-kapanış ve hava,deniz yolu ile üretim yerinden montaj yerine ulaşımı esnasında kendi içinde gösterdiği sıcaklık değişimlerine bağlı basınç sapsmalarıdır.
- Led armatür veya elektrik bağlantı kutularındaki basınç sabit tutma zorluğu ve buna önlem almak adına izole edilmeleri işçilik ve ekonomik açıdan pahalı bir çözüm olmaktadır. Tüm bu işlemler aynı zamanda ürünün toplam ağırlığını artırır ve herhangi bir arıza durumunda tamir işlemini zorlaştırır.
- İklim farklılıkları beraberinde getirdiği hava değişimlerinden dolayı oluşan basınç farklılıkları led armatür ve elektrik bağlantı kutularının içinde bağıl neme bağlı yoğuşmaya sebep olur.ventil rakor ve tapa kullanılan ürünlerde oluşan nem hızlı bir şekilde tahliye edildiği için yoğuşma görülmemiştir.
- Orvent ventil rakor ve tapaları tüm bu zorlukları ortadan kaldırır ve ekonomik çözüm sunduğu gibi cihazın ömrünü uzatır.

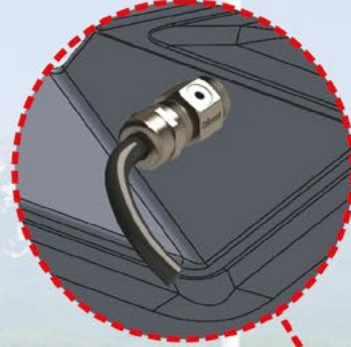
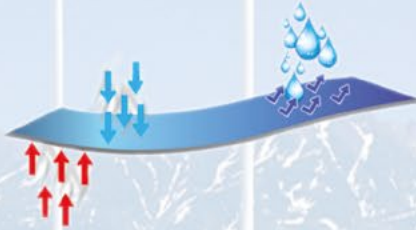
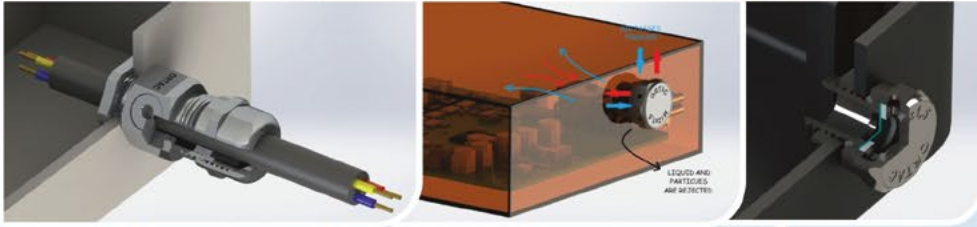

## ORvent BASINÇ Dengeleme BİLEŞENLERİ

- Cihazın içindeki basıncın artmasını engeller
- Hava sirkülasyonunu sağlayarak ısı yükselişini engeller
- Ortamdaki neme bağlı oluşabilecek olumsuz etkileri minimuma indirir hatta tamamen etkisizleştirir
- Havalandırma rakorları GAZ, BUHAR,HAVA gibi elementleri geçirgen olup SU ve Toz geçirmez.
- Aydınlatma ürünlerindeki neme bağlı yoğunlaşma ve buharlaşma sorununu ortadan kaldırarak periyodik temizlik maliyetlerini minimuma indirir ve ürün ömrünü uzatır





## KABLO RAKORLARI & AKSESUARLARI

# ORvent® BASINÇ DENGELEME BİLEŞENLERİ

### ORvent HAVALANDIRMA TAPALARI (Pirinç - Paslanmaz- Polyamide)

Boy	Kod	Cinsi	GL	H	Ortalama Hava Geçirgen	Su Sızdırmazlık Basıncı Mbar	Kutu Adedi	Birim Fiyatı Euro
M4x0,7	OMBVP4S	Pirinç	3	10	6	0,1	100	2,88
M4x0,7	OMSVP4S	Paslanmaz	3	10	6	0,1	100	6,13
M8x1,25	OMBVP8S	Pirinç	6	13	6	0,1	100	2,88
M8x1,25	OMSVP8S	Paslanmaz	6	13	6	0,1	100	6,13
M10x1,5	OMBVP10S	Pirinç	6	13	6	0,1	100	2,88
M10x1,5	OMSVP10S	Paslanmaz	6	13	6	0,1	100	6,13
M 12	OMSVP01SL	Paslanmaz	10	14	16	0,8	100	6,83
M 12	OMBVP01SL	Pirinç	10	18	16	0,8	100	3,39
M 12	OMVPL0 1SL	Polyamide	10	19	16	0,8	100	1,19



### ORvent HAVALANDIRMA KABLO RAKORLARI (Polyamide)

Ölçü	Kod Gri	Kod Siyah	GL	H	Ortalama Hava Geçirgen	Sıkma Aralık	Kutu Adedi	Birim Fiyatı Euro
M12	OMVGL 01	OMVGB 01	8	29	0,1MBAR 70	4-6,5	100	1,98
M16	OMVGL 02	OMVGB 02	8	33	0,1MBAR 70	4-8	100	1,98
M16	OMVGL 03	OMVGB 03	10	34	0,1MBAR 70	5-10	100	2,10
M20	OMVGL 04RS	OMVGB 04RS	10	40,5	0,1MBAR 70	4-9	100	3,31
M20	OMVGL 04	OMVGB 04	10	40,5	0,1MBAR 70	6-12	100	3,31
PG7	OPVGL 01	OPVGB 01	8	29	0,1MBAR 70	4-8	100	1,98
PG9	OPVGL 02	OPVGB 02	8	33	0,1MBAR 70	4-8	100	1,98
PG11	OPVGL 03	OPVGB 03	10	34	0,1MBAR 70	5-10	100	2,10
PG13,5	OPVGL 04RS	OPVGB 04RS	10	34	0,1MBAR 70	4-9	100	3,31
PG13,5	OPVGL 04	OPVGB 04	10	34	0,1MBAR 70	6-12	100	3,31



### ORvent HAVALANDIRMA KABLO RAKORLARI (Pirinç-Paslanmaz)

Ölçü	Pirinç Kod	Paslanmaz Kod	GL	H	Sıkma Aralık	Ortalama Hava Geçirgen	Kutu Adedi	Pirinç Birim Fiyatı Euro	Paslanmaz Birim Fiyatı Euro
M12	OMBVG01	OMSVG01	6	31,5	4-8	0,1MBAR 70	100	5,85	13,44
M12	OMBVG01L	OMSVG01L	8	31,5	4-8	0,1MBAR 70	100	5,85	13,44
M16	OMBVG02R	OMSVG02R	6	31,5	4-8	0,1MBAR 70	100	5,85	13,44
M16	OMBVG02RL	OMSVG02RL	8	31,5	4-8	0,1MBAR 70	100	5,85	13,44
M16	OMBVG02	OMSVG02	6	31,5	5-10	0,1MBAR 70	100	5,85	13,44
M16	OMBVG02L	OMSVG02L	8	31,5	5-10	0,1MBAR 70	100	5,85	13,44
M20	OMBVG03	OMSVG03	8	35	6-12	0,1MBAR 70	100	6,64	16,13
PG7	OPBVG01	OPSVG01	6	31,5	4-8	0,1MBAR 70	100	5,85	13,44
PG7	OPBVG01L	OPSVG01L	8	31,5	4-8	0,1MBAR 70	100	5,85	13,44
PG9	OPBVG02	OPSVG02	6	31,5	4-8	0,1MBAR 70	100	5,85	13,44
PG9	OPBVG02L	OPSVG02L	8	31,5	4-8	0,1MBAR 70	100	5,85	13,44
PG11	OPBVG03	OPSVG03	6	31,5	5-10	0,1MBAR 70	100	5,85	13,44
PG11	OPBVG03L	OPSVG03L	8	31,5	5-10	0,1MBAR 70	100	6,17	13,44
PG13,5	OPBVG04	OPSVG04	6,5	35	6-12	0,1MBAR 70	100	6,64	16,13
PG13,5	OPBVG04L	OPSVG04L	8	35	6-12	0,1MBAR 70	100	6,64	16,13



### MEBRAN DEĞERLERİ

Ölçü	Membran Kodu	Ortalama Hava Geçirgen	Su Sızdırmazlık Basıncı Mbar
M12x1,5	S	16	0,8
M12x1,5	H	150	0,2
M12x1,5	UH	300	0,1



# We Establish Safety Connection In Hazardous Areas



**ORTAC**

**Ex**

CABLE GLANDS & ACCESSORIES



# ATEX DIRECTIVE 94/9/EC

**ATEX**; Avrupa Birliği Organizasyonlarının ATEX direktifleri 1 Temmuz 2003 tarihinden itibaren uygulanmaya konulmuş olup, 20 Nisan 2016 tarihi itibari ile 2014/34/AB yönetmeliği adı altında revize edilmiştir. **ATEX**, Fransızca “**ATmosphères EXplosives**” kelimelerinin ilk hecelerinin birleşiminden oluşmuş bir kelimedir ve **Patlayıcı Atmosferler** anlamına gelmektedir. Günümüzde Avrupa birliği ülkelerinde geçerli olan ve Avrupa dışında birçok ülkede de referans olarak kabul edilen **ATEX** yönetmelikleri patlayıcı ortamlar, güvenlik önlemleri ve burada kullanılan ekipmanların sahip olması gereken minimum şartları belirtmektedir.

- **94/9/AT (ATEX 95)** Muhtemel patlayıcı ortamda kullanılan teçhizat ve koruyucu sistemler ile ilgili yönetmelik, (19 Nisan 2016 tarihine kadar) - **2014/34/AB (ATEX 114)** Muhtemel patlayıcı ortamda kullanılan teçhizat ve koruyucu sistemler ile ilgili yönetmelik, (20 Nisan 2016 tarihinden itibaren) - **99/92/AT (ATEX 137)** Patlayıcı ortamların tehlikelerinden çalışanların korunması hakkında yönetmelik.

**2014/34/AB** yönetmeliği kullanılan ekipmanları, **99/92/AT** yönetmeliği ise patlayıcı ortamı ve güvenlik önlemlerini ortaya koymaktadır. Ancak bu yönetmelikler içerik bakımından genelleştirilmiş ifadelerden oluşmaktadır. Bu yüzden ilgili ortam ve ekipmanların yönetmeliklere uyumunu belirlemek için ayrı ayrı standartlar ve sertifikasyon süreçleri tanımlanmıştır.

**Exproof**; potansiyel yanıcı ve patlayıcı ortamlarda kullanılmak amacıyla özel olarak üretilen Ekipman ve Koruyucu Sistemlerin genel adıdır. Alevlenebilir kimyasallar ve petrol ürünlerinin (örneğin metan, alkol, asetilen, doğalgaz...) üretim, işletme, ulaştırma ve depolanmasında ortaya çıkabilecek gaz ve buhar kaçaklarının, atmosferin oksijeniyle birleşmesiyle, patlayıcı bir konsantrasyonu oluşturması kaçınılmazdır.

Böylesi bir durumda elektrik enerjisinden doğabilecek, elektrik arki, statik elektrik ya da aşırı yüzey sıcaklığı, mal ve can güvenliğini tehlikeye sokacak bir patlamaya yol açabilmektedir. Söz konusu tehlikeli ortamlarda kullanılan elektrik ekipmanlarının yapımı ve kullanımı normal sahalardaki uygulamalardan büyük farklılıklar göstermektedir. Bu tür malzemeler, konu ile ilgilenen meslek çevrelerince **Ex-Proof (Alev sızdırmaz)** elektrik malzemeleri olarak isimlendirilir. Patlayıcı, parlayıcı ve kolay yanıcı ortamlarda kullanılan ekipmanların üzerlerinde özel kodlar bulunmaktadır. Amaç tehlikeli ortamlarda çalışan personelin bu kodlara dikkat ederek doğru ekipmanı doğru bölgede kullanmasıdır. Her exproof ekipman her bölgede kullanılamaz. Patlamaların çoğu yanlış bölgede yanlış ekipman / bileşen seçiminden kaynaklanır.

Üst kategorilerdeki aletler alt kategorilerde de kullanılabilir. Fakat alt kategorilerdeki ekipman / bileşenler üst kategorilerde asla kullanılamaz. Kategorisi 1 olan bir alet **ZONE 0-ZONE 1-ZONE 2** de rahatlıkla kullanılır. Ancak kategorisi 2 olan bir alet **ZONE 0** da asla kullanılamaz.



## EX-PROOF KABLO RAKORLARI & AKSESUARLARI

**I II 2G 2D Ex d IIC T6 Gb Db M2 Mb**  
 1 2 3 4 5 6 7 8 9 10 11 12

<b>ATEX Sembol</b>		Ekipmanın ATEX özelliği olduğunu ifade eden semboldür.
<b>Ekipman Grup</b>	1	Grizu Ortamında Kullanılan Cihazlar
	2	Grizu Dışındaki Patlayıcı Gaz
<b>Ekipman Kategorisi</b>	3,4	Ekipmanın hangi "Zone" içinde kullanılacağına göre değeri değişir.
<b>Zone bilgileri</b>	<b>Gazlar için;</b>	Zone 0: Patlayıcı gazın sürekli ve uzun sürelerde ya da sıklıkla bulunduğu ortamlar
		Zone 1: Patlayıcı gazın oluşma ihtimalinin bulunduğu ortamlar
		Zone 2: Patlayıcı gazın nadiren ya da kısa süreli olarak bulunduğu ortamlar
	<b>Tozlar için;</b>	Zone 20: Patlayıcı tozun sürekli ve uzun sürelerde ya da sıklıkla bulunduğu ortamlar
		Zone 21: Patlayıcı tozun oluşma ihtimalinin bulunduğu ortamlar
		Zone 22: Patlayıcı tozun nadiren ya da kısa süreli olarak bulunduğu ortamlar. Buna göre ekipman kategorilerini Zone bölgelerine göre şu şekilde gruplandırabiliriz
		1G: Zone 0, Zone 1 ve Zone 2 ortamların hepsinde kullanılabilir.
		2G: Zone 0 ve Zone 1 ortamların ikisinde de kullanılabilir.
		3G: Sadece Zone 2 ortamlarda kullanılabilir.
		1D: Zone 20, Zone 21 ve Zone 22 ortamların hepsinde kullanılabilir.
2D: Zone 20 ve Zone 21 ortamların ikisinde de kullanılabilir.		
3D: Sadece Zone 22 ortamlarda kullanılabilir.		
<b>Ex-proof İşaret</b>	5	Ekipmanın ex-proof özelliği olduğunu ifade eden işarettir, koruma tipiyle birlikte kullanılır.
<b>Koruma Tipi</b>	6	Zone sınıflandırmasına bağlı olarak farklı tipte koruma şekilleri mevcuttur
<b>Koruma Tipi Zone Sınıfları</b>	Ex d:	Alev sızdırmaz kapatma; Zone 1 ve Zone 2
	Ex e:	Artırılmış güvenlik; Zone 1 ve Zone 2
	Ex i:	Düşük akım/voltaj ile kendinden güvenli (gazlar için); ia (Zone 0, Zone, 1, Zone 2), ib (Zone, 1, Zone 2), ic (Zone 2)
	Ex iD:	Düşük akım/voltaj ile kendinden güvenli (tozlar için); iaD (Zone 20, Zone, 21, Zone 22), ibD (Zone, 21, Zone 22), icD (Zone 22)
	Ex p:	Pozitif basınçlandırılmış cihaz (gazlar için); Zone 1 ve Zone 2 (İç basınç)
	Ex o:	Yağa daldırma; Zone 1 ve Zone 2
	Ex q:	Toz doldurma; Zone 1 ve Zone 2 (Pudra dolgu)
	Ex n:	Kıvılcım çıkartmaz; Zone 2
Ex t:	Toz tutuşturma koruma tipi; ta (Zone 20, Zone, 21, Zone 22), tb (Zone, 21, Zone 22), tc (Zone 22)	
<b>Patlama Grubu</b>	7	Ortamda bulunan patlayıcı malzemenin cinsini belirtir.
<b>Gazlar için;</b>	IIA gaz örnekleri:	Amonyak, metan, etan, propan, etanol, siklo-hekzan, n-bütan, petrol, dizel yakıtı, fule oil, n-hekzan, asetaldehit
	IIB gaz örnekleri:	Hava gazı, akrilik nitril, etilen, etilen oksit, etil glikol, etil eter
	IIC gaz örnekleri:	Hidrojen, asetilen, karbon disülfid
	IIB patlama grubuna sahip ekipmanlar IIA gazlarına karşı da koruma sağlar. IIC patlama grubuna sahip ekipmanlar IIA ve IIB gazlarına karşı da koruma sağlar.	
<b>Tozlar için;</b>	IIIA toz örnekleri:	Yanıcı fiberler
	IIIB toz örnekleri:	İletken olmayan tozlar
	IIIC toz örnekleri:	İletken olan tozlar
IIIB patlama grubuna sahip ekipmanlar IIIA tozlarına karşı da koruma sağlar. IIIC patlama grubuna sahip ekipmanlar IIIA ve IIIB tozlarına karşı da koruma sağlar.		
<b>Sıcaklık Sınıfı</b>	8	Ekipmanda oluşabilecek maksimum yüzey sıcaklığını belirtir. Yanıcı patlayıcı malzemenin kendiliğinden alev alma riski için bu sınıf çok önemlidir.
<b>Gazlar için;</b>	T1:	<450 °C
	T2:	<300 °C
	T3:	<200 °C
	T4:	<135 °C
	T5:	<100 °C
	T6:	<85 °C
	Tozlar için maksimum yüzey sıcaklık değeri direkt olarak yazılır, örneğin T80°C gibi.	
<b>Ekipman Koruma Seviyesi</b>	9,10	Db: Zone 20 ve Zone 21 ortamların ikisinde de kullanılabilir.
<b>Koruma Tipi</b>	Ga:	Zone 0, Zone 1 ve Zone 2 ortamların hepsinde kullanılabilir.
	Gb:	Zone 0 ve Zone 1 ortamların ikisinde de kullanılabilir.
	Gc:	Sadece Zone 2 ortamlarda kullanılabilir.
	Da:	Zone 20, Zone 21 ve Zone 22 ortamların hepsinde kullanılabilir.
	Dc:	Sadece Zone 22 ortamlarda kullanılabilir.
<b>Koruma Tipi</b>	11	m2: Maden Ocakları Yer altı ve Yer üstü Gen. Mek.
	12	mb: tek arızalar için kendinden emniyetli

## EX-PROOF KABLO RAKORLARI & AKSESUARLARI

	EXO SERİSİ	MERAPİ UAG SERİSİ	UNZEN UG SERİSİ	ETNA DCG SERİSİ	COLİMA ACG SERİSİ	UAGT SERİSİ	EXMLS.. SERİSİ
<b>Type</b>	ExO Series (Polyamide Ex-proof gland)	UAG (Un-ar) Unarmoured gland	UG (Un-ar) Ar-moured gland	DCG (Double compression gland)	ACG (Ar-mou-red cable gland)	UAGT Screened EMC Ex gland	EXMLS. (Un-ar) Ar-moured conduit gland
<b>Certificate</b>	IEP 20 ATEX 0750 X ATEX, ROHS, CE, PT, TUV	IEP 14 ATEX 0217X ATEX, ROHS, CE, PT, TUV	IEP 14 ATEX 0217X ATEX, ROHS, CE, PT, TUV	IEP 14 ATEX 0216X, ATEX, ROHS, CE, PT, TUV	IEP 14 ATEX 0215X ATEX, ROHS, CE, PT, TUV	IEP 14 ATEX 0217X, ATEX, ROHS, CE, PT, TUV	IEP 15 ATEX 0355 X, ATEX, ROHS, CE, PT, TUV
<b>Protection Code</b>	II 2G Ex eb IIC Gb II 2D Ex tb IIIC Db	I M2 Ex db I Mb / I M2 Ex eb I Mb II 2G Ex db IIC Gb / II 2G Ex eb II Gb II 2D Ex tb IIIC Db	I M2 Ex db I Mb / I M2 Ex eb I Mb II 2G Ex db IIC Gb / II 2G Ex eb II Gb II 2D Ex tb IIIC Db	sIM2 Ex db IMb II 2G Ex db IIC Gb, II 2D Ex tb IIIC D6	I M2 Ex db I Mb II 2G Ex db IIC Gb II 2D Ex tb IIIC Db	I M2 Ex db I Mb / I Ex eb I Mb II 2G Ex db IIC Gb, II 2G Ex eb II Gb II 2D Ex tb IIIC Db	I M2 Ex db I Mb / I M2 Ex eb I Mb II 2G Ex db IIC Gb / II 2G Ex eb II Gb II 1D Ex ta IIIC Da
<b>Standarts</b>	EN 60079-0, 60079-7, 60079-31	EN 60079-0:2012, 60079-7:2007, 60079-1:2007, 60079-31:2009	EN 60079-0:2012, 60079-7:2007, 60079-1:2007, 60079-31:2009	EN 60079-0:2012, 60079-1:2007, 60079-31:2009	EN 60079-0:2012, 60079-1:2007, 60079-31:2009	EN 60079-0:2012, 60079-7:2007, 60079-1:2007, 60079-31:2009	EN 60079-0:2012, 60079-1:2007, 60079-7:2007, 60079-31:2009
<b>Protection Class</b>	P68 5 Bar	IP68	IP66 / 68	IP66 / 68	IP66 / 68	IP68	IP67
<b>Temperature Range</b>	-30 °C +100 °C	-30 °C +120 °C NBR, -40 °C +100 °C NEOPRENE, -60 °C +180 °C SILICONE, -30 °C +100 °C TPE/V	-30 °C +120 °C NBR, -40 °C +100 °C NEOPRENE, -60 °C +180 °C SILICONE, -30 °C +100 °C TPE/V	-30 °C +120 °C NBR, -40 °C +100 °C NEOPRENE, -60 °C +180 °C SILICONE, -30 °C +100 °C TPE/V	-30 °C +120 °C NBR, -40 °C +100 °C NEOPRENE, -60 °C +180 °C SILICONE, -30 °C +100 °C TPE/V	-30 °C +120 °C NBR, -40 °C +100 °C NEOPRENE, -60 °C +180 °C SILICONE, -30 °C +100 °C TPE/V	-20 °C +100 °C -30 °C +150 °C
<b>Material</b>	Polyamide PA6	MS58 Brass with or without nickel plated, Stainless steel AISI303 / 316L / Aluminium	MS58 Brass with or without nickel plated, Stainless steel AISI303 / 316L / Aluminium	MS58 Brass with or without nickel plated, Stainless steel AISI303 / 316L / Aluminium	MS58 Brass with or without nickel plated, Stainless steel AISI303 / 316L / Aluminium	MS58 Brass with or without nickel plated, Stainless steel AISI303 / 316L / Aluminium	MS58 Brass with or without nickel plated, Stainless steel AISI303 / 316L / Aluminium
<b>Colour</b>	Black (RAL 9005) - Blue (RAL 5015) Black Blue (RAL 9005 - RAL 2015)						
<b>Earthing Cone</b>						MS58 Brass with or without nickel plated	
<b>Application Area</b>	ZONE1, ZONE2, ZONE21, ZONE22, Gas Group IIA, IIB, IIC	ZONE1, ZONE2, ZONE21, ZONE22, Gas Group IIA, IIB, IIC	ZONE1, ZONE2, ZONE21, ZONE22, Gas Group IIA, IIB, IIC	ZONE1, ZONE2, ZONE21, ZONE22, Gas Group IIA, IIB, IIC	ZONE1, ZONE2, ZONE21, ZONE22, Gas Group IIA, IIB, IIC	ZONE1, ZONE2, ZONE21, ZONE22, Gas Group IIA, IIB, IIC	ZONE1, ZONE2, ZONE21, ZONE22, Gas Group IIA, IIB, IIC
<b>Cable Type</b>	Unarmoured	Unarmoured	Unarmoured	SWA (Single wire armour), (STA & other cables optional)	SWA (Single wire armour), (STA & other cables optional)	Screened lines & Screened cables	Unarmoured



## EX-PROOF KABLO RAKORLARI & AKSESUARLARI

# PART NUMBERING

W	DCG	B	1	*	**	K	t
		N	2			E	p
		Sa	3				
		Sb	4				
		Sc					
		A					

WDCGN1-20-M20-t DCGSc2 -20-M-20-K  
DCGN1-20-M20-t DCGSc2-20-M20-Kt



W	Without Certification (Industrial)	
DCG	Name Of Gland	
B	Brass	
N	Nickel Plating	
Sa	AISI303 Stainless Steel	
Sb	AISI304 Stainless Steel	
Sc	AISI316L Stainless Steel	
A	Aluminium	
	TPV Seal (-30 / +100 °C)	
1	PA6 V0 Washer (-40/+100 °C)	1a
	PA6 V0 Upper Washer (-40/+100 °C)	
2	Nbr Seal (-30 / +100 °C)	2a
	PA6 V0 Washer (-40/+100 °C)	
	PA6 V0 Upper Washer (-40/+100 °C)	
3	Neoprene Seal (-40/+100 °C)	3a 3a2
	PA6 V0 Washer (-40/+100 °C)	
	PA6 V0 Upper Washer (-40/+100 °C)	
4	Silicone Seal (-60 / +180 °C)	4a
	Silicone Washer (-60 / +180 °C)	
	Teflone Upper Silicone Seal (-60 / +180 °C)	
*	Cable Dia	
**	Thread Type	
K	Kit (Earth Tag + PVC Shroud)	
E	Earth Tag	
T	TPV Shroud (halogen free)	
P	PVC Shroud	

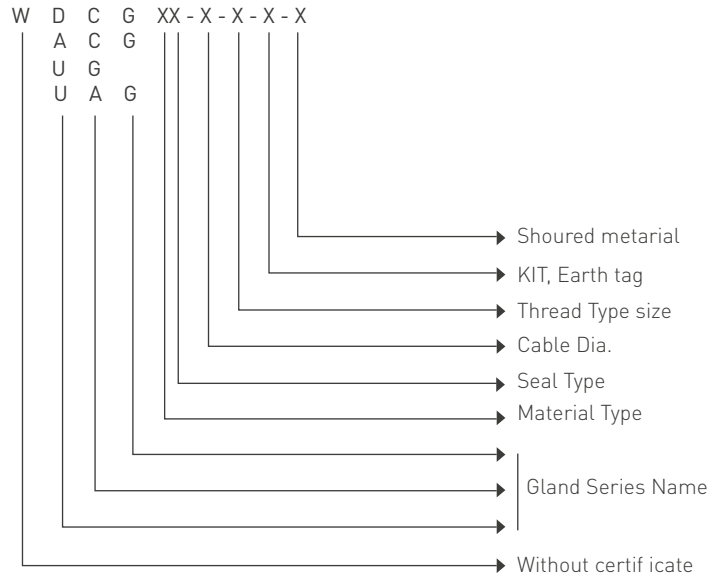

### Alternative Washer Options

1a	Nbr Washer (-30 / + 100 °C)
2a	Nbr Washer (-30 / + 100 °C)
3a	Nbr Washer (-30 / + 100 °C)
3a2	Neoprene Washer (-40 / + 100 °C)
3b	Teflone Upper Washer (-200 / + 260 °C)
4a	Teflone Upper Washer (-200 / + 260 °C)

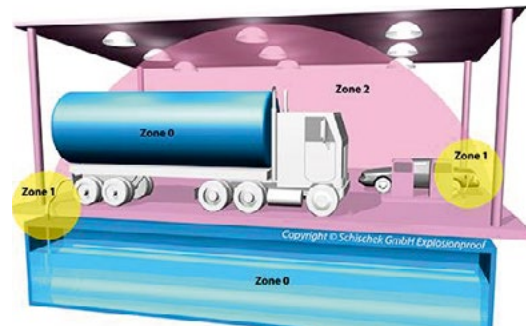

### Example Parts Numbering

DCGN1-32-M32	M32x1,5 Etna Serie Double Compression Brass Nickel Plated Ex Cable Glands
DCGN1-32-M32-K	M32x1,5 Etna Serie Double Compression Brass Nickel Plated Ex Cable Glands Kit
ACGSa2-32-M32	M32x1,5 Colima Serie Single Compression 303 Stainless Steel Ex Cable Glands
ACGSa2-32-M32-E	M32x1,5 Colima Serie Single Compression 303 Stainless Steel Ex Cable Glands + Earth Tag
DCGSc3-32-N1/2	NPT 1/2 Etna Serie Double Compression 316L Stainless Steel Ex Cable Glands + Shroud
DCGSc3-32-G1/2-t	GAS 1/2 Etna Serie Double Compression 316L Stainless Steel Ex Cable Glands + TPV Shroud
ACGSc3 -32-P11s-Kt	PG11s Colima Serie Single Compression 316L Stainless Steel Ex Cable Glands + Kit (with TPV Shroud)



## EX-PROOF KABLO RAKORLARI & AKSESUARLARI

### EXO SERİSİ

#### EXO SERİSİ TEK SIKMALI EX-PROOF PLASTİK KABLO RAKORLARI

Boy	Siyah Kod RAL 9005	Diş Uzunluğu min. mm	Montaj Çapı	Sıkma Çapı	Kutu Adedi	Birim Fiyatı Euro
PG-7	ExOXXORB 01	8	13	3-6,5	100	<b>0,86</b>
PG-9	ExOXXORB 02	8	16	4-8	100	<b>1,04</b>
PG-11	ExOXXORB 03	8	19	5-10	100	<b>1,19</b>
PG-13.5	ExOXXORB 04RS	9	21	4-10	50	<b>1,36</b>
PG-13.5	ExOXXORB 04	9	21	6-12	50	<b>1,36</b>
PG-16	ExOXXORB 05	9	23	10-14	50	<b>1,58</b>
PG-21	ExOXXORB 06	11	29	13-18	50	<b>2,35</b>
PG-21	ExOXXORB 06/9-17	11	29	9-17	50	<b>2,35</b>
PG-29	ExOXXORB 07	11	37,5	18-25	25	<b>4,92</b>
PG-36	ExOXXORB 08	13	47,5	22-32	10	<b>7,98</b>
PG-42	ExOXXORB 09	13	54,5	30-38	5	<b>10,23</b>
PG-48	ExOXXORB 10	14	60	34-44	5	<b>13,21</b>



• RAL 9005-Siyah

UZUN DIŞ

PG-7	ExOXXORBL 01	15	13	3-6,5	100	<b>0,95</b>
PG-9	ExOXXORBL 02	15	16	4-8	100	<b>1,14</b>
PG-11	ExOXXORBL 03	15	19	5-10	100	<b>1,30</b>
PG-13.5	ExOXXORBL 04RS	15	21	4-10	50	<b>1,49</b>
PG-13.5	ExOXXORBL 04	15	21	6-12	50	<b>1,49</b>
PG-16	ExOXXORBL 05	15	23	10-14	50	<b>1,74</b>
PG-21	ExOXXORBL 06	15	29	13-18	50	<b>2,58</b>
PG-21	ExOXXORBL 06/9-17	15	29	9-17	50	<b>2,58</b>

#### EXO SERİSİ TEK SIKMALI EX-PROOF PLASTİK KABLO RAKORLARI - METRİK

M 12 x 1,5	ExOXXOMRB 01	8	12,5	3-6,5	100	<b>0,86</b>
M 16 x 1,5	ExOXXOMRB 02	8	16,5	4-8	100	<b>1,04</b>
M 16 x 1,5	ExOXXOMRB 03	10	16,5	5-10	100	<b>1,19</b>
M 20 x 1,5	ExOXXOMRB 04RS	10	20,5	4-10	50	<b>1,36</b>
M 20 x 1,5	ExOXXOMRB 04	10	20,5	6-12	50	<b>1,36</b>
M 20 x 1,5	ExOXXOMRB 05	10	20,5	10-14	50	<b>1,58</b>
M 25 x 1,5	ExOXXOMRB ES4	10	25,5	4-10	50	<b>2,35</b>
M 25 x 1,5	ExOXXOMRB ES6	10	25,5	6-12	50	<b>2,35</b>
M 25 x 1,5	ExOXXOMRB E6-9	10	25,5	9-14	50	<b>2,35</b>
M 25 x 1,5	ExOXXOMRB E6	10	25,5	11-17	50	<b>2,35</b>
M 25 x 1,5	ExOXXOMRB 06	10	25,5	13-18	50	<b>2,35</b>
M 32 x 1,5	ExOXXOMRB E7	10	32,5	15-21	25	<b>4,92</b>
M 32 x 1,5	ExOXXOMRB 07	10	32,5	18-25	25	<b>4,92</b>
M 40 x 1,5	ExOXXOMRB E8	10	40,5	19-28	10	<b>7,98</b>
M 40 x 1,5	ExOXXOMRB 08	10	40,5	22-32	10	<b>7,98</b>
M 50 x 1,5	ExOXXOMRB 09	18	50,5	30-38	5	<b>10,23</b>
M 63 x 1,5	ExOXXOMRB 10	18	63,5	34-44	5	<b>13,21</b>
G3/4"	ExOXXOGRB 06	10	26,5	13-18	50	<b>2,35</b>
G3/4"	ExOXXOGRB 06/9-17	10	26,5	9-17	50	<b>2,35</b>



• RAL 9005-Siyah

UZUN DIŞ

M 12 x 1,5	ExOXXOMRB 01L	15	12,5	3-6,5	100	<b>0,95</b>
M 16 x 1,5	ExOXXOMRB 11S	15	16,5	4-8	100	<b>1,14</b>
M 16 x 1,5	ExOXXOMRB 11	15	16,5	5-10	100	<b>1,30</b>
M 20 x 1,5	ExOXXOMRB 12RS	15	20,5	4-10	50	<b>1,49</b>
M 20 x 1,5	ExOXXOMRB 12	15	20,5	6-12	50	<b>1,49</b>
M 20 x 1,5	ExOXXOMRB 13	15	20,5	10-14	50	<b>1,74</b>
M 25 x 1,5	ExOXXOMRB ES14	15	25,5	4-10	50	<b>2,58</b>
M 25 x 1,5	ExOXXOMRB ES16	15	25,5	6-12	50	<b>2,58</b>
M 25 x 1,5	ExOXXOMRB E14-9	15	25,5	9-14	50	<b>2,58</b>
M 25 x 1,5	ExOXXOMRB E14	15	25,5	11-17	50	<b>2,58</b>
M 25 x 1,5	ExOXXOMRB 14	15	25,5	13-18	50	<b>2,58</b>
M 32 x 1,5	ExOXXOMRB E15	15	32,5	15-21	25	<b>5,41</b>
M 32 x 1,5	ExOXXOMRB 15	18	32,5	18-25	25	<b>5,41</b>
M 40 x 1,5	ExOXXOMRB E16	15	40,5	19-28	10	<b>8,78</b>
M 40 x 1,5	ExOXXOMRB 16	18	40,5	22-32	10	<b>8,78</b>



• RAL 9005-Siyah



## EX-PROOF KABLO RAKORLARI & AKSESUARLARI

### MERAPİ SERİSİ

#### MERAPİ UAG SERİSİ TEK SIKMALI EX-PROOF ZIRHSIZ KABLO RAKORLARI



EXD

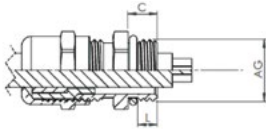

EXE

Boy	Kod	Standart Ölçü METRİK	NPT	Diş Uzunluk mm.	Kablo Sıkma Çapı	Kutu Adedi	Birim Fiyatı €
12	UAGXX-12-X	M12x1,5	1/4"	15	3-6,5	100	
16	UAGXX-16-X	M16x1,5	3/8"	15	4-8	50	
20	UAGXX-20-X	M20x1,5	1/2"	15	6-12	25	
20s	UAGXX-20s-X	M20x1,5	1/2"	15	4-10	25	
25s	UAGXX-25s-X	M25x1,5	3/4"	15	10-14	25	
25L	UAGXX-25L-X	M25x1,5	3/4"	15	9-17	25	
25	UAGXX-25-X	M25x1,5	3/4"	15	13-18	25	
32	UAGXX-32-X	M32x1,5	1"	15	13-18	20	
40	UAGXX-40-X	M40x1,5	1 1/4"	15	18-25	10	
50	UAGXX-50-X	M50x1,5	1 1/2"	15	22-32	5	
63s	UAGXX-63s-X	M63x1,5	2"	15	33-44	5	
63	UAGXX-63-X	M63x1,5	2"	15	45-50	5	
75s	UAGXX-75s-X	M75x1,5	2 1/2"	20	45-55	2	
75	UAGXX-75-X	M75x1,5	2 1/2"	20	50-63	2	
80	UAGXX-80-X	M80x2,0	3"	20	50-63	1	
90	UAGXX-90-X	M90x2,0	3"	20	60-70	1	
12	EUAGXX-12-X	M12x1,5	1/4"	6	3-6,5	100	
16	EUAGXX-16-X	M16x1,5	3/8"	7	4-8	50	
20s	EUAGXX-20s-X	M20x1,5	1/2"	8	4-10	25	
20	EUAGXX-20-X	M20x1,5	1/2"	8	6-12	25	
25s	EUAGXX-25s-X	M25x1,5	3/4"	8	10-14	25	
25L	EUAGXX-25L-X	M25x1,5	3/4"	8	9-17	25	
25	EUAGXX-25-X	M25x1,5	3/4"	8	13-18	25	
32	EUAGXX-32-X	M32x1,5	1"	9	13-18	20	
40	EUAGXX-40-X	M40x1,5	1 1/4"	9	18-25	10	
50	EUAGXX-50-X	M50x1,5	1 1/2"	9	22-32	5	
63s	EUAGXX-63s-X	M63x1,5	2"	14	33-44	5	



### UNZEN SERİSİ

#### UNZEN UG SERİSİ TEK SIKMALI EX-PROOF ZIRHSIZ KABLO RAKORLARI

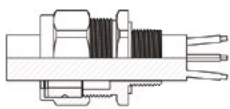

Boy	Ölçü Kod	Standart Ölçü Metrik	NPT	Diş Uzunluk mm.	Kablo Sıkma Çapı		Kutu Adedi	Birim Fiyatı €
					Min	Max		
16	UGXX-16-X	M16x1,5	1/2"	15	6,1	11,6	50	
20s	UGXX-20s-X	M20sx1,5	1/2"	15	6,1	13,2	25	
20	UGXX-20-X	M20x1,5	1/2"	15	9,5	15,9	25	
25	UGXX-25-X	M25x1,5	3/4"	15	12,5	20,5	25	
32	UGXX-32-X	M32x1,5	1"	15	18,2	26,2	20	
40	UGXX-40-X	M40x1,5	1 1/4"	15	23,7	33,9	10	
50	UGXX-50-X	M50x1,5	1 1/2"	15	27,9	40,4	5	
63s	UGXX-63s-X	M63sx1,5	2"	15	40,4	51	5	
63	UGXX-63-X	M63x1,5	2 1/2"	15	47,2	55,9	5	
75s	UGXX-75s-X	M75sx1,5	2 1/2"	15	52,8	61,9	2	
75	UGXX-75-X	M75x1,5	3"	15	59,1	67,9	2	



MERAPİ Serisi UAG

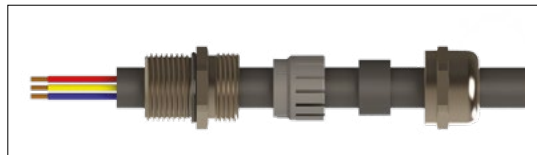

UNZEN Serisi UG

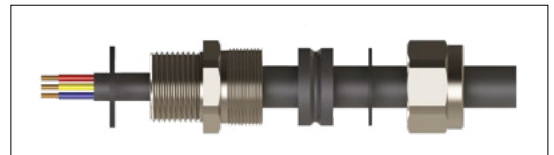



## EX-PROOF KABLO RAKORLARI & AKSESUARLARI

### STEX SERİSİ

#### STEX SERİSİ TEK SIKMALI SİRAL UÇLU EX-PROOF ZIRHSIZ KABLO RAKORLARI

	Boy	Kod	Standart Ölçü	Spiral Ölçü (d)	Exe Diş Uz. mm	Clamping Range mm	Birim Fiyatı €
METRİK SERİSİ	12	STEXX-12-X	M 12 x 1,5	6,8	6	3 - 6,5	
	16	STEXX-16-X	M 16 x 1,5	8,2	6	4-8	
	20	STEXX-20-X	M 20 x 1,5	12,3	6,5	6-12	
	25	STEXX-25-X	M 25 x 1,5	14,3	6,5	10-14	
	32	STEXX-32-X	M 32 x 1,5	18,4	7	13 - 18	
PG SERİSİ	12	STEXX-12-X	PG 7	6,8	6	3 - 6,5	
	16	STEXX-16-X	PG 9	8,2	6	4-8	
	16	STEXX-16-X	PG 11	10,3	6	5-10	
	20	STEXX-20-X	PG 13,5	12,3	6,5	6-12	
	25	STEXX-25-X	PG 16	14,3	6,5	10-14	
NPT SERİSİ	12	STEXX-12-X	NPT 1/4"	6,8	-	3 - 6,5	
	16	STEXX-16-X	NPT 3/8"	8,2	-	4-8	
	16	STEXX-16-X	NPT 1/2"	10,3	-	5-10	
	20	STEXX-20-X	NPT 1/2"	12,3	-	6-12	
	25	STEXX-25-X	NPT 3/4"	14,3	-	10-14	
32	STEXX-32-X	NPT 1"	18,4	-	13 - 18		



### EXMLS SERİSİ

#### EXMLS.. SERİSİ HARİCİ TİP KABLO TUTUCULU EX-PROOF SİRAL RAKORLARI

	Boy	Kod	Uygun Spiral Ölçüsü	Diş Uzunluk mm.	Sıkma Aralığı mm	Birim Fiyatı
METRİK SERİSİ	M 12 x 1,5	ExMLSRXX-12-X-X	10-1/4"	15	3-6,5	
	M 16 x 1,5	ExMLSRXX-16-X-X	10-1/4"	15	4-8	
	M 16 x 1,5	ExMLSRXX-16-X-X	13-3/8"	15	5-10	
	M 20 x 1,5	ExMLSRXX-20-X-X	16-1/2"	15	6-12	
	M 25 x 1,5	ExMLSRXX-25-X-X	21-3/4"	15	10-14	
	M 32 x 1,5	ExMLSRXX-32-X-X	26-1"	15	13-18	
	M 40 x 1,5	ExMLSRXX-40-X-X	35-1 1/4"	15	18-25	
	M 50 x 1,5	ExMLSRXX-50-X-X	40-1 1/2"	15	22-32	
	M 63 x 1,5	ExMLSRXX-63-X-X	51-2"	15	34-44	
	M 72 x 1,5	ExMLSRXX-72-X-X	63-2 1/2"	20	45-55	
	M 75 x 1,5	ExMLSRXX-75-X-X	78-3"	20	50-63	
	M 90 x 2	ExMLSRXX-90-X-X	102-4"	20	60-70	
	NPT SERİSİ	1/4"	ExMLSRXX-12-X-X	10 - 1/4"	10	3-6,5
3/8"		ExMLSRXX-16-X-X	10 - 1/4"	10	4-8	
3/8"		ExMLSRXX-16-X-X	13 - 3/8"	11,5	5-10	
1/2"		ExMLSRXX-20-X-X	16 - 1/2"	13	6-12	
3/4"		ExMLSRXX-25-X-X	21 - 3/4"	15	10-14	
1"		ExMLSRXX-32-X-X	26 - 1"	15	13-18	
1 1/4"		ExMLSRXX-40-X-X	35 - 1 1/4"	16	18-25	
1 1/2"		ExMLSRXX-50-X-X	40 - 1 1/2"	18	22-32	
2"		ExMLSRXX-63-X-X	51 - 2"	20	34-44	
2 1/2"		ExMLSRXX-72-X-X	63 - 2 1/2"	20	45-55	
PG SERİSİ	3"	ExMLSRXX-75-X-X	78-3"	24	50-63	
	4"	ExMLSRXX-90-X-X	102-4"	30	60-70	
	4"	Ex-MLSRN 10	102-4"	30	60-70	
	PG 7	ExMLSRXX-12-X-X	10-1/4"	15	3-6,5	
	PG 9	ExMLSRXX-16-X-X	10-1/4"	15	4-8	
	PG 11	ExMLSRXX-16-X-X	13-3/8"	15	5-10	
	PG 13,5	ExMLSRXX-20-X-X	16-1/2"	15	6-12	
	PG 16	ExMLSRXX-25-X-X	16-1/2"	15	10-14	
	PG 21	ExMLSRXX-32-X-X	21-3/4"	15	13-18	
	PG 29	ExMLSRXX-40-X-X	26-1"	15	18-25	
PG 36	ExMLSRXX-50-X-X	35-1 1/4"	15	22-32		
PG 42	ExMLSRXX-42-X-X	40-1 1/2"	15	30-38		
PG 48	ExMLSRXX-63-X-X	51-2"	15	34-44		



## EX-PROOF KABLO RAKORLARI & AKSESUARLARI

### ETNA SERİSİ

#### ETNA DCG SERİSİ ÇİFT SIKMALI EX-PROOF ZIRHLI KABLO RAKORLARI



Boy	Kod	Standart Ölçü METRİK	NPT	PG	Alt Conta kablo sıkma aralığı A		Üst Conta kablo sıkma aralığı B		Dış Uzunluk mm.	Birim Fiyatı
					Min	Max	Min	Max		
16	DCGXX-16-X	M16x1,5	1/2"	PG9	3,1	8,6	6,1	13,2	15	
20ss	DCGXX-20ss-X	M20ssx1,5	1/2"	PG11ss	3,1	8,6	6,1	13,2	15	
20s	DCGXX-20s-X	M20sx1,5	1/2"	PG11s	6,1	11,6	9,5	15,9	15	
20	DCGXX-20-X	M20x1,5	1/2"	PG13,5	6,5	13,9	12,5	20,9	15	
25s	DCGXX-25s-X	M25sx1,5	3/4"	PG21s	11,1	19,9	14	22	15	
25	DCGXX-25-X	M25x1,5	3/4"	PG21	11,1	19,9	18,2	26,2	15	
32	DCGXX-32-X	M32x1,5	1"	PG29	18,2	26,2	23,7	33,9	15	
40	DCGXX-40-X	M40x1,5	1 1/4"	PG36s	23,7	33,9	27,9	40,4	15	
50s	DCGXX-50s-X	M50sx1,5	1 1/2"	PG36	29,5	38,1	35,2	46,7	15	
50	DCGXX-50-X	M50x1,5	2"	PG42	35,6	44	40,4	53,1	15	
63s	DCGXX-63s-X	M63sx1,5	2"	PG48	40,1	49,9	45,6	59,4	15	
63	DCGXX-63-X	M63x1,5	2 1/2"	-	47,2	55,9	54,6	65,9	15	
75s	DCGXX-75s-X	M75sx1,5	2 1/2"	-	52,8	61,9	59	72,1	15	
75	DCGXX-75-X	M75x1,5	3"	-	59,1	67,9	66,7	78,5	15	
90	DCGXX-90-X	M90x2	3 1/2"	-	66,6	79,9	76,2	90,4	24	
100	DCGXX-100-X	M100x2	-	-	76	90	86,1	101,5	24	
115	DCGXX-115-X	M115x2	-	-	86	97,9	101,5	110,3	24	
130	DCGXX-130-X	M130x2	-	-	97	114,9	114,2	123,3	24	



### COLİMA SERİSİ

#### COLİMA ACG SERİSİ TEK SIKMALI EX-PROOF ZIRHLI KABLO RAKORLARI



Boy	Kod	Standart Metrik-AG	NPT-AG	PG-AG	A		B		Dış Uzunluk	Birim Fiyatı
					Min	Max	Min	Max		
16	ACGXX/16/X	M16x1,5	1/2"	PG9	8,6	6,1	13,2	15		
20ss	ACGXX/20ss/X	M20ssx1,5	1/2"	PG11ss	8,6	6,1	13,2	15		
20s	ACGXX/20s/X	M20sx1,5	1/2"	PG11s	11,6	9,5	15,9	15		
20	ACGXX/20/X	M20x1,5	1/2"	PG13,5	13,9	12,5	20,9	15		
25s	ACGXX/25s/X	M25sx1,5	3/4"	PG21s	19,9	14	22	15		
25	ACGXX/25/X	M25x1,5	3/4"	PG21	19,9	18,2	26,2	15		
32	ACGXX/32/X	M32x1,5	1"	PG29	26,2	23,7	33,9	15		
40	ACGXX/40/X	M40x1,5	1 1/4"	PG36s	33,9	27,9	40,4	15		
50s	ACGXX/50s/X	M50sx1,5	1 1/2"	PG36	38,1	35,2	46,7	15		
50	ACGXX/50/X	M50x1,5	2"	PG42	44,0	40,4	53,1	15		
63s	ACGXX/63s/X	M63sx1,5	2"	PG48	49,9	45,6	59,4	15		
63	ACGXX/63/X	M63x1,5	2 1/2"	-	55,9	54,6	65,9	15		
75s	ACGXX/75s/X	M75sx1,5	2 1/2"	-	61,9	59	72,1	15		
75	ACGXX/75/X	M75x1,5	3"	-	67,9	66,7	78,5	15		
90	ACGXX/90/X	M90x2,0	3"	-	79,9	76,2	90,4	15		
100	ACGXX/100/X	M100x2,0	-	-	90	86,1	101,5	15		
115	ACGXX/115/X	M115x2,0	-	-	97,9	101,5	110,3	15		
130	ACGXX/130/X	M130x2,0	-	-	114,9	114,2	123,3	15		



## EX-PROOF KABLO RAKORLARI & AKSESUARLARI

### UAGT SERİSİ

#### UAGT SERİSİ EMC EXPROOF ZIRHLI KABLO RAKORLARI

Boy	Kod	Standart Ölçü METRİK	NPT	Dış Uzunluk mm.	Kablo Sıkma Çapı	Birim Fiyatı €
16	UAGTXX/16/X	M16x1,5	3/8"	15	4-8	
20	UAGTXX/20/X	M20x1,5	1/2"	15	6-12	
25s	UAGTXX/25s/X	M25x1,5	3/4"	15	10-14	
25	UAGTXX/25/X	M25x1,5	3/4"	15	13-18	
32	UAGTXX/32/X	M32x1,5	1"	15	13-18	
32L	UAGTXX/32L/X	M32x1,5	1"	15	18-25	
40	UAGTXX/40/X	M40x1,5	1 1/4"	15	18-25	
40L	UAGTXX/40L/X	M40x1,5	1 1/4"	15	22-32	
50	UAGTXX/50/X	M50x1,5	1 1/2"	15	22-32	
50L	UAGTXX/50L/X	M50x1,5	1 1/2"	15	30-38	
63s	UAGTXX/63s/X	M63x1,5	2"	15	33-44	
63	UAGTXX/63/X	M63x1,5	2"	15	45-55	
72	UAGTXX/72/X	M72x1,5	2 1/2"	20	50-63	
75s	UAGTXX/75s/X	M75x1,5	2 1/2"	20	45-55	
75	UAGTXX/75/X	M75x1,5	2 1/2"	20	50-63	
80	UAGTXX/80/X	M80x2,0	3"	20	50-63	

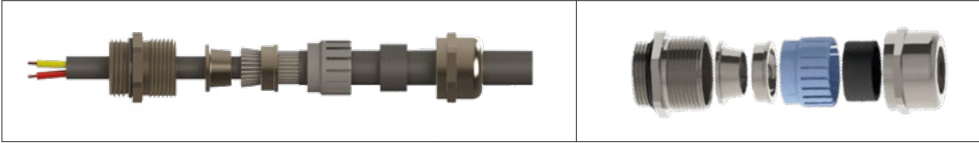

#### RAKOR KILIFI / SHROUD

Boy	Kod	Delik Çapı Ø D mm	Tam Boy Uzunluk	Rakor Giriş Boyu mm	Birim Fiyatı €
M16	PS1-16	25	100	60	
M20ss	PS1-16	25	100	60	
M20s	PS1-16	25	100	60	
M20	PS1-20	31	110	65	
M25	PS1-25	41	130	70	
M32	PS1-32	49	145	80	
M40	PS1-40	59	165	85	
M50s	PS1-50s	64	150	85	
M50	PS1-50	75	170	90	
M63s	PS1-63s	81	175	90	
M63	PS1-63	86	175	90	
M75s	PS1-75s	98	210	115	
M75	PS1-75	108	220	115	



#### TOPRAKLAMA EKİPMANI / EARTH TAG

Boy	Kod	Vida Çapı	Delik Çapı	Birim fiyatı €
M16	RTEN-16	6,5	16,5	
M20	RTEN-20	6,5	20,5	
M25	RTEN-25	6,5	25,5	
M32	RTEN-32	10,5	32,5	
M40	RTEN-40	12,5	40,5	
M50	RTEN-50	12,5	50,5	
M63	RTEN-63	12,5	63,5	
M75	RTEN-75	12,5	75,5	
M90	RTEN-90	12,5	90,5	
M100	RTEN-100	12,5	100,5	



## EX-PROOF KABLO RAKORLARI & AKSESUARLARI

### ATEX TK SERİSİ KÖRTAPA



#### TECHNICAL DETAILS

Type	TK-XX / STOPPER PLUG
Protection Code	II 2G Exd/e IIC Gb II 1D Ex ta IIIC Da I M2 Ex d/e I Mb
Certificate	IEP 15 ATEX 0333 U

### ATEX TS SERİSİ KÖRTAPA



#### TECHNICAL DETAILS

Type	TS-XX / STOPPER PLUG
Protection Code	II 2G Exd/e IIC Gb II 1D Ex ta IIIC Da I M2 Ex d/e I Mb
Certificate	IEP 15 ATEX 0333 U

### ATEX TO SERİSİ KÖRTAPA



#### TECHNICAL DETAILS

Type	TO-XX / STOPPER PLUG
Protection Code	II 2G Exd/e IIC Gb II 1D Ex ta IIIC Da I M2 Ex d/e I Mb
Certificate	IEP 15 ATEX 0333 U

Kod	Ebat	GL (mm)
TK-XX/M12	M12 x 1,5	14
TK-XX/M16	M16 x 1,5	14
TK-XX/M20	M20 x 1,5	14
TK-XX/M25	M25 x 1,5	14
TK-XX/M32	M32 x 1,5	14
TK-XX/M40	M40 x 1,5	16
TK-XX/M50	M50 x 1,5	16
TK-XX/M63	M63 x 1,5	16
TK-XX/M75	M75 x 1,5	18
TK-XX/M90	M90 x 1,5	18
TK-XX/M110	M110 x 1,5	18
TK-XX/N14	NPT 1/4"	16
TK-XX/N38	NPT 3/8"	16
TK-XX/N12	NPT 1/2"	18
TK-XX/N34	NPT 3/4"	18
TK-XX/N100	NPT 1"	21
TK-XX/N114	NPT 1 1/4"	21
TK-XX/N112	NPT 1 1/2"	21
TK-XX/N200	NPT 2"	21
TK-XX/N212	NPT 2 1/2"	28
TK-XX/N300	NPT 3"	28
TK-XX/N400	NPT 4"	28
TK-XX/G14	G 1/4"	16
TK-XX/G38	G 3/8"	16
TK-XX/G12	G 1/2"	16
TK-XX/G34	G 3/4"	16
TK-XX/G100	G 1"	20
TK-XX/G114	G 1 1/4"	20
TK-XX/G112	G 1 1/2"	20
TK-XX/G200	G 2"	20
TK-XX/G212	G 2 1/2"	20
TK-XX/G300	G 3"	20
TK-XX/G400	G 4"	20
TK-XX/P7	PG7	15
TK-XX/P9	PG9	15
TK-XX/P11	PG 11	15
TK-XX/P13	PG 13,5	15
TK-XX/P16	PG16	15
TK-XX/P21	PG21	15
TK-XX/P29	PG29	15
TK-XX/P36	PG36	15
TK-XX/P42	PG42	15
TK-XX/P48	PG48	15

Kod	Ebat	GL (mm)
TS-XX-M12	M12 x 1,5	M12 x 1,5
TS-XX-M16	M16 x 1,5	M16 x 1,5
TS-XX-M20	M20 x 1,5	M20 x 1,5
TS-XX-M25	M25 x 1,5	M25 x 1,5
TS-XX-M32	M32 x 1,5	M32 x 1,5
TS-XX-M40	M40 x 1,5	M40 x 1,5
TS-XX-M50	M50 x 1,5	M50 x 1,5
TS-XX-M63	M63 x 1,5	M63 x 1,5
TS-XX-M75	M75 x 1,5	M75 x 1,5
TS-XX-M90	M90 x 1,5	M90 x 1,5
TS-XX-M110	M110 x 1,5	M110 x 1,5
TS-XX-N14	NPT 1/4"	NPT 1/4"
TS-XX-N38	NPT 3/8"	NPT 3/8"
TS-XX-N12	NPT 1/2"	NPT 1/2"
TS-XX-N34	NPT 3/4"	NPT 3/4"
TS-XX-N100	NPT 1"	NPT 1"
TS-XX-N114	NPT 1 1/4"	NPT 1 1/4"
TS-XX-N112	NPT 1 1/2"	NPT 1 1/2"
TS-XX-N200	NPT 2"	NPT 2"
TS-XX-N212	NPT 2 1/2"	NPT 2 1/2"
TS-XX-N300	NPT 3"	NPT 3"
TS-XX-N400	NPT 4"	NPT 4"
TS-XX-G14	G 1/4"	G 1/4"
TS-XX-G38	G 3/8"	G 3/8"
TS-XX-G12	G 1/2"	G 1/2"
TS-XX-G34	G 3/4"	G 3/4"
TS-XX-G100	G 1"	G 1"
TS-XX-G114	G 1 1/4"	G 1 1/4"
TS-XX-G112	G 1 1/2"	G 1 1/2"
TS-XX-G200	G 2"	G 2"
TS-XX-G212	G 2 1/2"	G 2 1/2"
TS-XX-G300	G 3"	G 3"
TS-XX-G400	G 4"	G 4"
TS-XX-P7	PG7	PG7
TS-XX-P9	PG9	PG9
TS-XX-P11	PG 11	PG 11
TS-XX-P13	PG 13,5	PG 13,5
TS-XX-P16	PG16	PG16
TS-XX-P21	PG21	PG21
TS-XX-P29	PG29	PG29
TS-XX-P36	PG36	PG36
TS-XX-P42	PG42	PG42
TS-XX-P48	PG48	PG48

Kod	Ebat	GL (mm)	Allen
TO-XX/M12	M12 x 1,5	15	6
TO-XX/M16	M16 x 1,5	15	8
TO-XX/M20	M20 x 1,5	15	10
TO-XX/M25	M25 x 1,5	15	10
TO-XX/M32	M32 x 1,5	15	10
TO-XX/M40	M40 x 1,5	15	10
TO-XX/M50	M50 x 1,5	15	10
TO-XX/M63	M63 x 1,5	15	12
TO-XX/M75	M75 x 1,5	15	12
TO-XX/M90	M90 x 1,5	15	12
TO-XX/M100	M100 x 1	15	12
TO-XX/N14	NPT 1/4"	15	6
TO-XX/N38	NPT 3/8"	15	8
TO-XX/N12	NPT 1/2"	15	10
TO-XX/N34	NPT 3/4"	15	10
TO-XX/N100	NPT 1"	15	10
TO-XX/N114	NPT 1 1/4"	15	10
TO-XX/N112	NPT 1 1/2"	15	10
TO-XX/N200	NPT 2"	15	12
TO-XX/N212	NPT 2 1/2"	15	12
TO-XX/N300	NPT 3"	15	12
TO-XX/N400	NPT 4"	15	12
TO-XX/G14	G 1/4"	15	6
TO-XX/G38	G 3/8"	15	8
TO-XX/G12	G 1/2"	15	10
TO-XX/G34	G 3/4"	15	10
TO-XX/G100	G 1"	15	10
TO-XX/G114	G 1 1/4"	15	10
TO-XX/G112	G 1 1/2"	15	10
TO-XX/G200	G 2"	15	12
TO-XX/G212	G 2 1/2"	15	12
TO-XX/G300	G 3"	15	12
TO-XX/G400	G 4"	15	12
TO-XX/P7	PG7	15	6
TO-XX/P9	PG9	15	8
TO-XX/P11	PG 11	15	10
TO-XX/P13	PG 13,5	15	10
TO-XX/P16	PG16	15	10
TO-XX/P21	PG21	15	10
TO-XX/P29	PG29	15	10
TO-XX/P36	PG36	15	12
TO-XX/P42	PG42	15	12
TO-XX/P48	PG48	15	12



## EX-PROOF KABLO RAKORLARI & AKSESUARLARI

### ATEX RC SERİSİ REDÜKSİYON



### ATEX RC SERİSİ BÜYÜTÜCÜ REDÜKSİYON



### ATEX TO SERİSİ KÖRTAPA



#### TECHNICAL DETAILS

Type	RCXX / REDUCER
Protection Code	II 2G Exd/e IIC Gb II 1D Ex ta IIIC Da I M2 Ex d/e I Mb
Certificate	IEP 15 ATEX 0333 U ZONE1 , ZONE 2, ZONE 21 , ZONE 22
Application Area	Gas groups IIA , IIB , IIC

#### TECHNICAL DETAILS

Type	RCXX / ENLARGER REDUCER
Protection Code	II 2G Exd/e IIC Gb II 1D Ex ta IIIC Da I M2 Ex d/e I Mb
Certificate	IEP 15 ATEX 0333 U ZONE1 , ZONE 2, ZONE 21 , ZONE 22
Application Area	Gas groups IIA , IIB , IIC

#### TECHNICAL DETAILS

Type	APXX / ADAPTOR
Protection Code	II 2G Exd/e IIC Gb II 1D Ex ta IIIC Da I M2 Ex d/e I Mb
Certificate	IEP 15 ATEX 0333 U ZONE1 , ZONE 2, ZONE 21 , ZONE 22
Application Area	Gas groups IIA , IIB , IIC

Kod	AG (M)	IG (F)
RCXX/M12m-M12f	M12 x 1,5	M12 x 1,5
RCXX/M12m-M16f	M12 x 1,5	M16 x 1,5
RCXX/M16m-M16f	M16 x 1,5	M16 x 1,5
RCXX/M12m-M20f	M12 x 1,5	M20 x 1,5
RCXX/M16m-M20f	M16 x 1,5	M20 x 1,5
RCXX/M20m-M20f	M20 x 1,5	M20 x 1,5
RCXX/M16m-M25f	M16 x 1,5	M25 x 1,5
RCXX/M20m-M25f	M20 x 1,5	M25 x 1,5
RCXX/M25m-M25f	M25 x 1,5	M25 x 1,5
RCXX/M20m-M32f	M20 x 1,5	M32 x 1,5
RCXX/M25m-M32f	M25 x 1,5	M32 x 1,5
RCXX/M32m-M32f	M32 x 1,5	M32 x 1,5
RCXX/M25m-M40f	M25 x 1,5	M40 x 1,5
RCXX/M32m-M40f	M32 x 1,5	M40 x 1,5
RCXX/M40m-M40f	M40 x 1,5	M40 x 1,5
RCXX/M32m-M50f	M32 x 1,5	M50 x 1,5
RCXX/M40m-M50f	M40 x 1,5	M50 x 1,5
RCXX/M50m-M50f	M50 x 1,5	M50 x 1,5
RCXX/M50m-M63f	M50 x 1,5	M63 x 1,5
RCXX/M63m-M63f	M63 x 1,5	M63 x 1,5
RCXX/M63m-M75f	M63 x 1,5	M75 x 1,5
RCXX/M75m-M75f	M75 x 1,5	M75 x 1,5
RCXX/M75m-M90f	M75 x 1,5	M90 x 1,5
RCXX/M90m-M90f	M90 x 1,5	M90 x 1,5
RCXX/M90m-M110f	M90 x 1,5	M110 x 1,5
RCXX/M110m-M110f	M110 x 1,5	M110 x 1,5
RCXX/N14m-N14f	NPT 1/4"	NPT 1/4"
RCXX/N14m-N38f	NPT 1/4"	NPT 3/8"
RCXX/N38m-N38f	NPT 3/8"	NPT 3/8"
RCXX/N38m-N12f	NPT 3/8"	NPT 1/2"
RCXX/N12m-N12f	NPT 1/2"	NPT 1/2"
RCXX/N12m-N34f	NPT 1/2"	NPT 3/4"
RCXX/N34m-N34f	NPT 3/4"	NPT 3/4"
RCXX/N34m-N100f	NPT 3/4"	NPT 1"
RCXX/N100m-N100f	NPT 1"	NPT 1"
RCXX/N100m-N114f	NPT 1"	NPT 1 1/4"
RCXX/N114m-N114f	NPT 1 1/4"	NPT 1 1/4"
RCXX/N114m-N112f	NPT 1 1/4"	NPT 1 1/2"
RCXX/N112m-N112f	NPT 1 1/2"	NPT 1 1/2"
RCXX/N112m-N200f	NPT 1 1/2"	NPT 2"
RCXX/N200m-N200f	NPT 2"	NPT 2"
RCXX/N200m-N212f	NPT 2"	NPT 2 1/2"
RCXX/N212m-N212f	NPT 2 1/2"	NPT 2 1/2"
RCXX/N212m-N300f	NPT 2 1/2"	NPT 3"
RCXX/N300m-N300f	NPT 3"	NPT 3"
RCXX/N300m-N400f	NPT 3"	NPT 4"
RCXX/N400m-N 400f	NPT 4"	NPT 4"

Kod	AG (M)	IG (F)
RCXX/M16m-M12f	M16 x 1,5	M12 X 1,5
RCXX/M20m-M12f	M20 x 1,5	M12 X 1,5
RCXX/M20m-M16f	M20 x 1,5	M16 X 1,5
RCXX/M25m-M16f	M25 x 1,5	M16 X 1,5
RCXX/M25m-M20f	M25 x 1,5	M20 X 1,5
RCXX/M32m-M20f	M32 x 1,5	M20 X 1,5
RCXX/M32m-M25f	M32 x 1,5	M25X 1,5
RCXX/M40m-M25f	M40 x 1,5	M25X 1,5
RCXX/M40m-M32f	M40 x 1,5	M32 X 1,5
RCXX/M50m-M32f	M50 x 1,5	M32 X 1,5
RCXX/M50m-M40f	M50 x 1,5	M40 X 1,5
RCXX/M63m-M40f	M63 x 1,5	M40 X 1,5
RCXX/M63m-M50f	M63 x 1,5	M50 X 1,5
RCXX/M75m-M50f	M75 x 1,5	M50 X 1,5
RCXX/M75m-M63f	M75 x 1,5	M63X 1,5
RCXX/M90m-M63f	M90 x 1,5	M63X 1,5
RCXX/M90m-M75f	M90 x 1,5	M75 X 1,5
RCXX/M110m-M75f	M110 x 1,5	M75 X 1,5
RCXX/M110m-M90f	M110 x 1,5	M90 X 1,5
RCXX/N38m-N14f	NPT 3/8"	NPT 1/4"
RCXX/N12m-N14f	NPT 1/2"	NPT 1/4"
RCXX/N12m-N38f	NPT 1/2"	NPT 3/8"
RCXX/N34m-N38f	NPT 3/4"	NPT 3/8"
RCXX/N34m-N12f	NPT 3/4"	NPT 1/2"
RCXX/N100m-N12f	NPT 1"	NPT 1/2"
RCXX/N100m-N34f	NPT 1"	NPT 3/4"
RCXX/N114m-N12f	NPT 1 1/4"	NPT 1/2"
RCXX/N114m-N34f	NPT 1 1/4"	NPT 3/4"
RCXX/N114m-N100f	NPT 1 1/4"	NPT 1"
RCXX/N112m-N12f	NPT 1 1/2"	NPT 1/2"
RCXX/N112m-N34f	NPT 1 1/2"	NPT 3/4"
RCXX/N112m-N100f	NPT 1 1/2"	NPT 1"
RCXX/N112m-N114f	NPT 1 1/2"	NPT 1 1/4"
RCXX/N200m-N114f	NPT 2"	NPT 1 1/4"
RCXX/N200m-N112f	NPT 2"	NPT 1 1/2"
RCXX/N212m-N112f	NPT 2 1/2"	NPT 1 1/2"
RCXX/N212m-N200f	NPT 2 1/2"	NPT 2"
RCXX/N300m-N200f	NPT 3"	NPT 2"
RCXX/N300m-N212f	NPT 3"	NPT 2 1/2"
RCXX/N400m-N212f	NPT 4"	NPT 2 1/2"
RCXX/N400m-N300f	NPT 4"	NPT 3"

Kod	AG (M)	IG (F)
APXX/M16m-N14f	M16 x 1,5	NPT 1/4"
APXX/M20m-N14f	M20 x 1,5	NPT 1/4"
APXX/M25m-N12f	M25 x 1,5	NPT 1/2"
APXX/M32m-N12f	M32 x 1,5	NPT 1/2"
APXX/M32m-N34f	M32 x 1,5	NPT 3/4"
APXX/M40m-N34f	M40 x 1,5	NPT 3/4"
APXX/M40m-N100f	M40 x 1,5	NPT 1"
APXX/M50m-N100f	M50 x 1,5	NPT 1"
APXX/M50m-N114f	M50 x 1,5	NPT 1 1/4"
APXX/M63m-N114f	M63 x 1,5	NPT 1 1/4"
APXX/M63m-N112f	M63 x 1,5	NPT 1 1/2"
APXX/M75m-N112f	M75 x 1,5	NPT 1 1/2"
APXX/M75m-N200f	M75 x 1,5	NPT 2"
APXX/M90m-N200f	M90 x 1,5	NPT 2"
APXX/M90m-N212f	M90 x 1,5	NPT 2 1/2"
APXX/M110m-N212f	M110 x 1,5	NPT 2 1/2"
APXX/M110m-N300f	M110 x 1,5	NPT 3"
APXX/N38m-M12f	NPT 3/8"	M12 x 1,5
APXX/N12m-M12f	NPT 1/2"	M12 x 1,5
APXX/N12m-M16f	NPT 1/2"	M16 x 1,5
APXX/N34m-M16f	NPT 3/4"	M16 x 1,5
APXX/N34m-M20f	NPT 3/4"	M20 x 1,5
APXX/N100m-M20f	NPT 1"	M20 x 1,5
APXX/N100m-M25f	NPT 1"	M25 x 1,5
APXX/N114m-M25f	NPT 1 1/4"	M25 x 1,5
APXX/N114m-M32f	NPT 1 1/4"	M32 x 1,5
APXX/N112m-M32f	NPT 1 1/2"	M32 x 1,5
APXX/N112m-M40f	NPT 1 1/2"	M40 x 1,5
APXX/N200m-M40f	NPT 2"	M40 x 1,5
APXX/N200m-M50f	NPT 2"	M50 x 1,5
APXX/N212m-M50f	NPT 2 1/2"	M50 x 1,5
APXX/N212m-M63f	NPT 2 1/2"	M63 x 1,5
APXX/N300m-M63f	NPT 3"	M63 x 1,5
APXX/N300m-M75f	NPT 3"	M75 x 1,5
APXX/N400m-M75f	NPT 4"	M75 x 1,5
APXX/N400m-M90f	NPT 4"	M90 x 1,5



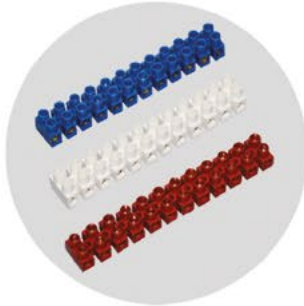
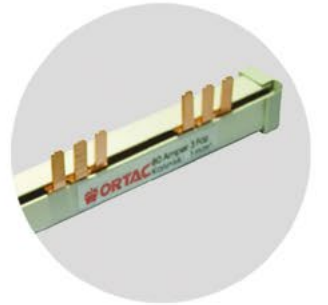
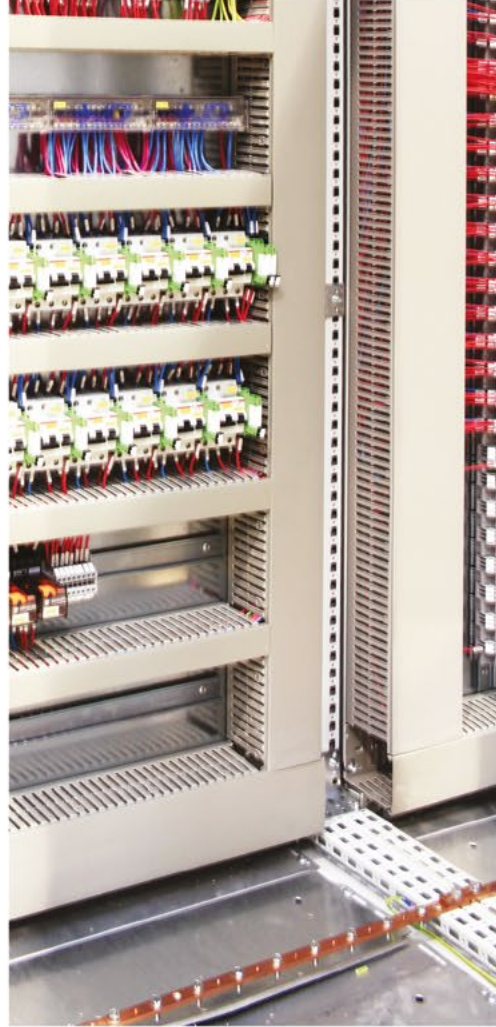

## KLEMENSLER

### YANMAZ SIRA KLEMENSLER (Beyaz / Kahverengi)

Kod	Boy	Kablo Kesit mm	Göz Adedi	Renk	Ambalaj Miktarı	Birim Fiyatı TL
YPLS 00	0 NO	1,5	12	Beyaz	50	<b>8,89</b>
YPLS 01	1 NO	2,5-4	12	Beyaz	50	<b>9,67</b>
YPLS 02	2 NO	4-6	12	Beyaz	50	<b>12,58</b>
YPLS 03	3 NO	6-10	10	Beyaz	50	<b>15,93</b>
YPLS 04	4 NO	10-16	6	Beyaz	50	<b>18,34</b>
YPLS 05	5 NO	16-25	6	Beyaz	50	<b>19,75</b>



### PLASTİK SIRA KLEMENSLER (Mavi / Siyah)

PLS 01	1 NO	2,5-4	12	Mavi	50	<b>9,46</b>
PLS 02	2 NO	4-6	12	Mavi	50	<b>12,20</b>
PLS 03	3 NO	6-10	10	Mavi	50	<b>15,40</b>
PLS 04	4 NO	10-16	6	Mavi	50	<b>18,14</b>
PLS 05	5 NO	16-25	6	Mavi	50	<b>19,55</b>



### SOKET KLEMENSLER

SK 102	1 NO	2,5-4	1 - 2	BEYAZ	50	<b>7,84</b>
SK 103	1 NO	2,5-4	1 - 3	BEYAZ	50	<b>11,75</b>
SK 104	1 NO	2,5-4	1 - 4	BEYAZ	50	<b>15,67</b>
SK 120	1 NO	2,5-4	12	BEYAZ	30	<b>47,02</b>



### KAPAKLI 3'LÜ SOKET KLEMENS

SK 103K	1 NO	2,5-4	1 - 2	SİYAH BEYAZ	100	<b>16,70</b>
---------	------	-------	-------	-------------	-----	--------------



### PORSELEN KLEMENSLER

PK 12	1 NO 2	2,5	2	Krem	150	<b>3,09</b>
PK 13	1 NO 3	4,6	3	Krem	100	<b>4,41</b>
PK 22	2 NO 2	4,6	2	Krem	100	<b>4,41</b>
PK 23	2 NO 3	6,4	3	Krem	50	<b>6,16</b>
PK 32	3 NO 2	6,1	2	Krem	50	<b>6,16</b>
PK 33	3 NO 3	6,1	3	Krem	35	<b>8,27</b>



### YAYLI / TIRNAKLI BUAT İÇİ KLEMENSLERİ

Kod	Renk	Kutup Sayısı	Kablo Kesit	Ambalaj Miktarı	Birim Fiyatı TL
PC-252	2 (KIRMIZI)	2	1,5mm <sup>2</sup>	1000	<b>1,26</b>
PC-253	3 (ORANJ)	3	2,5mm <sup>2</sup>	1000	<b>1,38</b>
PC-254	4 (SARI)	4	2,5mm <sup>2</sup>	1000	<b>1,66</b>
PC-255	5 (GRİ)	5	2,5mm <sup>2</sup>	1000	<b>1,90</b>
PC-258	8 (SİYAH)	8	2,5mm <sup>2</sup>	100	<b>4,35</b>



### Çok Amaçlı Tırnaklı Buat Klemens

PCT-24	ŞEFFAF	2	4	1000	<b>3,44</b>
PCT-34	ŞEFFAF	3	4	500	<b>4,39</b>
PCT-54	ŞEFFAF	5	4	250	<b>6,28</b>



## PANOLAR & KABLO KANALLARI

### ABS OPAK PANOLAR



KOD	ÜRÜN ÖLÇÜLERİ			ÜRÜN ÖZELLİK	KOLİ ADEDİ	Birim Fiyatı TL
	EN	BOY	DERİNLİK			
OP1002	21	x 28	x 13	Galvaniz Taban Sacı	1	169,39
OP1004	25	x 33	x 14	Galvaniz Taban Sacı	1	190,71
OP1007	30	x 40	x 17	Galvaniz Taban Sacı	1	251,28
OP1008	30	x 40	x 21	Galvaniz Taban Sacı	1	300,64
OP1009	35	x 50	x 22	Galvaniz Taban Sacı	1	385,90
OP1010	40	x 50	x 18	Galvaniz Taban Sacı	1	397,12
OP1012	40	x 60	x 20	Galvaniz Taban Sacı	1	493,59
OP1014	50	x 70	x 25	Galvaniz Taban Sacı	1	813,31

### ŞEFFAF ABS OPAK PANOLAR



OPS1002	21	x 28	x 13	Galvaniz Taban Sacı	1	190,71
OPS1004	25	x 33	x 14	Galvaniz Taban Sacı	1	229,97
OPS1007	30	x 40	x 17	Galvaniz Taban Sacı	1	314,10
OPS1008	30	x 40	x 21	Galvaniz Taban Sacı	1	364,59
OPS1009	35	x 50	x 22	Galvaniz Taban Sacı	1	476,77
OPS1010	40	x 50	x 18	Galvaniz Taban Sacı	1	482,37
OPS1012	40	x 60	x 20	Galvaniz Taban Sacı	1	588,95
OPS1014	50	x 70	x 25	Galvaniz Taban Sacı	1	998,40

#### TEKNİK ÖZELLİKLER

Hammadde: ABS

Renk: RAL 7035 Gri

Koruma sınıfı: IP65

Özellikler: Halogen free, Kırılmaz, Polüretan contalı

### STANDART PANO İÇİ DELİKLİ KABLO KANALLARI (2 mt.) RAL 7030 GRİ

Kod	Ölçü mm	Slot Aralığı mm	Ambalaj Miktarı mt	Birim Fiyatı TL / mt
ODK2525	25x25	4/6/4	100	19,72
ODK2540	25x40	4/6/4	80	24,86
ODK2560	25x60	4/6/4	48	32,80
ODK4040	40x40	4/6/4	72	32,56
ODK4060	40x60	4/6/4	48	39,75
ODK6060	60x60	4/6/4	32	51,58
ODK6080	60x80	4/6/4	24	64,81
ODK8060	80x60	4/6/4	24	65,60
ODK8080	80x80	4/6/4	18	74,30





## PANO MONTAJ EKİPMANLARI

### MÜŞTEREK BARA SİSTEMLERİ

#### TRİFAZE BARA SİSTEMLERİ

Kod	Cinsi	Kalınlık mm	Modül	Kutu Adedi	Birim Fiyatı TL
TMB 10A	TRİFAZE	1	53 CM / 10	25	Fiyat İsteyiniz
TMB 10B	TRİFAZE	1,5	53 CM / 10	25	Fiyat İsteyiniz
TMB 110A	TRİFAZE	1	106 CM / 20	10	Fiyat İsteyiniz
TMB 110B	TRİFAZE	1,5	106 CM / 20	10	Fiyat İsteyiniz

#### MONOFAZE BARA SİSTEMLERİ

Kod	Cinsi	Kalınlık mm	Modül	Kutu Adedi	Birim Fiyatı TL
MMB 10A	MONOFAZE	1	53 CM / 30	50	Fiyat İsteyiniz
MMB 10B	MONOFAZE	1,5	53 CM / 30	50	Fiyat İsteyiniz
MMB 110A	MONOFAZE	1	106 CM / 56	25	Fiyat İsteyiniz
MMB 110B	MONOFAZE	1,5	106 CM / 56	25	Fiyat İsteyiniz

#### NÖTR TOPRAKLAMA BARA SİSTEMLERİ

Kod	Cinsi	Kalınlık mm	Modül	Kutu Adedi	Birim Fiyatı TL
NTK 31A	NÖTR TOPRAKLAMA	1,5	15x1mt.31 Vida	25	Fiyat İsteyiniz
NTK 62A	NÖTR TOPRAKLAMA	1,5	15x1mt.61 Vida	25	Fiyat İsteyiniz
BM 01	BARA MESNEDİ	-	-	100	Fiyat İsteyiniz



### MONTAJ RAYLARI

Kod	Uzunluk	Genişlik/Derinlik mm	Ürün Özelliği	Kutu İçeriği mt.	Birim Fiyatı TL
ODSR02	1 mt	35*7,5	Deliksiz Montaj Rayı	50	17,66
ODSR03	2 mt.	35*7,5	Deliksiz Montaj Rayı	100	35,32
ODSR06	1 mt.	35*7,5	Delikli Montaj Rayı	50	17,66
ODSR07	2 mt.	35*7,5	Delikli Montaj Rayı	100	35,32
RTS	-	Ray Taşıyıcı Ayak - Sac		50	6,00
RTA	-	Ray Taşıyıcı Ayak - Aüminyum		50	6,80



### KABLO TOPLAMA ÇORAPLARI

Kod	Minimum Tutma Çapı	Maximum Tutma Çapı	Ambalaj Miktarı mt	Birim Fiyatı € Euro
OKC06	6	11	100	0,34
OKC08	8	12	100	0,47
OKC10	10	15	100	0,53
OKC12	12	19	50	0,66
OKC15	15	27	50	0,71
OKC20	20	28	50	0,95
OKC25	25	34	25	1,19
OKC30	30	37	25	1,58
OKC40	40	45	25	2,11
OKC50	50	65	25	2,77



### HELEZON PANO SİRALLERİ

Kod	Boy	Uzunluk cm	Ambalaj Miktarı	Birim Fiyatı TL
HPS 0	0 NO (3-4)	50	100	0,72
HPS 1	1 NO (3-5)	50	100	0,74
HPS 2	2 NO (5-7)	50	100	0,92
HPS 3	3 NO (8-10)	50	100	1,40
HPS 4	4 NO (10-14)	50	50	2,73
HPS 5	5 NO (14-16)	50	50	3,36



### HELEZON PANO SİRALLERİ (Rulo Tip)

Kod	Boy	Uzunluk cm	Ambalaj Miktarı	Birim Fiyatı TL
HPSR 0	0 NO (3-4)	50	100	1,45
HPSR 1	1 NO (3-5)	50	100	1,48
HPSR 2	2 NO (5-7)	50	100	1,85
HPSR 3	3 NO (8-10)	50	100	2,81
HPSR 4	4 NO (10-14)	50	50	5,47
HPSR 5	5 NO (14-16)	50	50	6,73



• Değişik renk seçenekleri mevcuttur



## BOBİNAJ EKİPMANLARI

### GAMAK TİPİ ORJİNAL MOTOR KLEMENSLERİ



Kod	Boy	Boy mm	En mm	Vida	Renk	Kutu Adedi	Birim Fiyatı TL
MK 01	56 - 63	40	25	M 4	SİYAH	50	5,76
MK 02	71 - 80 - 90 - 100	50	30	M 4		50	6,70
MK 03	132	60	37	M 5		50	8,66
MK 04	160 - 180	72	44	M 6		40	12,59
MK 05	225 - 250	91	56	M 8		15	23,43
MK 06	280	115	70	M 10		6	41,45

### GAMAK TİPİ ORJİNAL CAM ELYAFLI MOTOR KLEMENSLERİ



MKE 01	56 - 63	40	25	M 4	KAHVERENGİ	50	6,52
MKE 02	71 - 80 - 90 - 100	50	30	M 4		50	7,76
MKE 03	132	60	37	M 5		50	9,85
MKE 04	160 - 180	72	44	M 6		40	14,44
MKE 05	225 - 250	91	56	M 8		15	26,90
MKE 06	280	115	70	M 10		6	47,61

### GAMAK TİPİ ORJİNAL MOTOR PERVANELERİ



Kod	Boy mm	Bağ Adedi	Renk	Koli Miktarı	Birim Fiyatı TL
ORT 02	63	10	SİYAH	500	6,18
ORT 03	71	10		250	7,38
ORT 04	80	10		200	8,28
ORT 05	90	10		150	11,40
ORT 06	100-112	10		100	12,71
ORT 07	132	5		50	24,04
ORT 08	160	5		30	31,70
ORT 09	180	5		25	37,00
ORT 10	200-225-57	5		15	56,38
ORT 11	200-225-62	5		15	56,38

### KLEMENS KUTULARI



Kod	Cinsi	Boy	Kutu Adedi	Renk	Birim Fiyatı TL
PMK 01	0 NO	56 - 63	10	Gri	10,61
PMK 02	1 NO	71 - 80 - 90	10	Gri	12,41
PMK 03	2 NO	100 - 112	10	Gri	17,96
PMK 04	3 NO	132	5	Gri	33,49
PMKB 05	4 NO	160 - 180	5	Siyah	57,00

### WAT MOTOR PERVANELERİ



Kod	Boy	Birim Fiyatı TL
WQS63	63	36,68
WQS71	71	39,16
WQS80	80	41,67
WQS-QU90	90	45,52
WQS-QU100	100	49,26
WQS-QU112	112	67,29
WQS132	132	78,28
WQU160	160	134,56
WQU180	180	154,45
WQU200/2-4-8	200	223,24
WQU225/2	225	251,25
WQU250	250	251,25

## İZOLATÖRLER

### AG MESNET İZOLATÖRLER

#### MİNİ İZOLATÖR

Kod	Cinsi	Kutu Adedi	Birim Fiyatı TL
BMI-M5 2C	M5 Mini İzolatör	250	<b>3,87</b>
BMI-M5 1C+1S	M5 Mini İzolatör	250	<b>4,74</b>
BMI-M5 2S	M5 Mini İzolatör	250	<b>5,30</b>

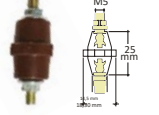

#### ORTA BOY FIÇI İZOLATÖR (m6-m8)

OBKI-M6 2C	M6 Orta Boy Konik İzolatör	50	<b>6,60</b>
OBKI-M6 1C+2S	M6 Orta Boy Konik İzolatör	50	<b>7,00</b>
OBKI-M6 2S	M6 Orta Boy Konik İzolatör	50	<b>7,90</b>
OBMI-M8 2C	M8 Orta Boy Fiçi İzolatör	50	<b>9,29</b>
OBMI-M8 1C+2S	M8 Orta Boy Fiçi İzolatör	50	<b>9,37</b>
OBMI-M8 2S	M8 Orta Boy Fiçi İzolatör	50	<b>9,48</b>

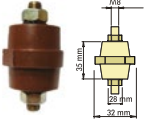

#### 40MM BÜYÜK BOY FIÇI İZOLATÖR (M8-M10)

BBMI-M8 2C	M8 Büyük Boy Fiçi İzolatör	40	<b>12,25</b>
BBMI-M8 1C+1S	M8 Büyük Boy Fiçi İzolatör	40	<b>14,46</b>
BBMI-M8 2S	M8 Büyük Boy Fiçi İzolatör	40	<b>14,62</b>
BBMI-M10 2C	M10 Büyük Boy Fiçi İzolatör	40	<b>18,06</b>
BBMI-M10 1C+1S	M10 Büyük Boy Fiçi İzolatör	40	<b>17,23</b>
BBMI-M10 2S	M10 Büyük Boy Fiçi İzolatör	40	<b>17,39</b>

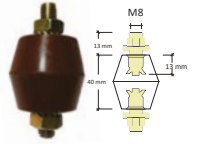

#### 50MM BÜYÜK BOY FIÇI İZOLATÖR (M10)

BMI-M 10 2C	M10 Büyük Boy Fiçi İzolatör	20	<b>22,29</b>
BMI-M 10 1C+1S	M10 Büyük Boy Fiçi İzolatör	20	<b>22,96</b>
BBMI-M 10 2S	M10 Büyük Boy Fiçi İzolatör	20	<b>22,92</b>

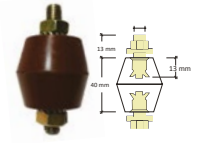

#### 3X1 F TARAK İZOLATÖR

3X1F	Tarak İzolatörü Kısa Tip	20	<b>18,18</b>
3X1F-U	Tarak İzolatörü Uzun Tip	40	<b>27,03</b>



#### 3X2 F TARAK İZOLATÖR

3X2F	Tarak İzolatörü	40	<b>28,06</b>
3X1F+N	Tarak İzolatörü	40	<b>28,45</b>
3X2F+N	Tarak İzolatörü	8	<b>37,54</b>
3X1FS	Tarak İzolatörü (Siyah)	30	<b>38,29</b>
3X2FS	Tarak İzolatörü (Siyah)	50	<b>68,19</b>

#### 1-500 İZOLATÖR

1N 50010	M10 1n-500 Mesnet İzolatör	12	<b>26,20</b>
1N 500102	M12 1n-500 Mesnet İzolatör	12	<b>32,29</b>



#### 1NK İZOLATÖR

1 NK 50016	M16 1nk İzolatör	12	<b>92,08</b>
BMS M8	M8 Bara Tutucu Serfil	50	<b>13,63</b>



## MAKARONLAR

### ISIYLA DARALAN MAKARONLAR



Kod	Ölçü mm	Renk	Ambalaj Miktarı	Birim Fiyatı USD
IDM 1,5	1,5 / 0,75	SİYAH	200	0,102
IDM 1,6	1,6 / 1		200	0,116
IDM 2	2 / 1		200	0,116
IDM 2,4	2,4 / 1,5		200	0,116
IDM 2,5	2,5 / 1,25		200	0,152
IDM 3	3 / 1,5		200	0,166
IDM 3,2	3,2 / 1,75		200	0,166
IDM 3,5	3,5 / 1,75		200	0,166
IDM 4	4 / 2		100	0,207
IDM 4,5	4,5 / 2,25		100	0,235
IDM 4,8	4,8 / 2,6		100	0,235
IDM 5	5 / 2,50		100	0,263
IDM 6	6 / 3		100	0,290
IDM 6,4	6,4 / 3,5		100	0,290
IDM 7	7 / 3,5		100	0,360
IDM 8	8 / 4		100	0,360
IDM 9,5	9,5 / 5		100	0,401
IDM 12,7	12,7 / 6,5		100	0,470
IDM 13	13 / 6,5		100	0,498
IDM 16	16 / 8		100	0,775
IDM 18	18 / 9	100	1,024	
IDM 19,1	19,1 / 10	100	1,024	
IDM 20	20 / 10	100	1,273	
IDM 22	22 / 11	100	1,591	
IDM 25,4	25,4 / 12	50	1,729	
IDM 30	30 / 15	50	2,213	
IDM 32	32 / 16,5	50	2,213	
IDM 35	35 / 17,5	50	2,766	
IDM 38	38 / 20	50	3,112	
IDM 40	40 / 20	50	3,112	
IDM 51	51 / 25	25	4,150	
IDM 60	60 / 30	25	5,671	
IDM 70	70 / 35	25	7,331	
IDM 80	80 / 40	25	8,438	
IDM 102	102 / 51	25	10,374	
IDM 120	120 / 60	25	15,215	

### ISIYLA DARALAN MAKARONLAR (Renkli)



Kod	Ölçü mm	Renk	Ambalaj Miktarı	Birim Fiyatı USD
IDMR 1,6 ...	2/1	ŞEFFAF BEYAZ KIRMIZI MAVİ YEŞİL GRİ	200	0,124
IDMR 2,4 ...	3/1,5		200	0,180
IDMR 3,2...	3,5/17,5		200	0,207
IDMR 4,8...	5,2/2,6		100	0,277
IDMR 6,4...	7/3,5		100	0,346
IDMR 9,5...	10/5		100	0,415
IDMR 12,7...	13/6,5		100	0,581
IDMR 16...	16,5/8		100	0,927
IDMR 19,1...	20,5/10		100	1,660
IDMR 25,4...	25,6/12		50	2,006
IDMR 32...	33/16,5		50	2,697
IDMR38...	40/20		50	4,150
IDMR51...	52,5/25		50	4,703
IDMR76...	80/40		25	9,129
IDMR102...	105/51		25	12,241



**YÜKSEK  
DAYANIM**



### VO - Yanmaz Polyamide Spiral Borular

Anma Çapı	Siyah Kod	İç Çap mm.	Dış Çap mm.	Ambalaj Miktarı	Minimum Sipariş Miktarı
7	OSPA V0 7	7	10	100	1000
8,5	OSPA V0 8,5	8,5	12	100	1000
9	OSPA V0 9	10	13	100	1000
11	OSPA V0 11	12	15,8	50	1000
13,5	OSPA V0 13,5	14,2	18,4	50	1000
16	OSPA V0 16	16,5	21,2	50	1000
21	OSPA V0 21	23,5	28,4	50	1000
29	OSPA V0 29	29	34,5	25	1000
36	OSPA V0 36	36	42,5	25	500
48	OSPA V0 48	48	54,5	25	500



### UV Dayanımlı Polyamide Spiral Borular

Anma Çapı	Siyah Kod	İç Çap mm.	Dış Çap mm.	Ambalaj Miktarı	Minimum Sipariş Miktarı
7	OSUV 07	7	10	100	1000
8,5	OSUV 08,5	8,5	12	100	1000
9	OSUV 09	10	13	100	1000
11	OSUV 11	12	15,8	50	1000
13,5	OSUV 13,5	14,2	18,4	50	1000
16	OSUV 16	16,5	21,2	50	1000
21	OSUV 21	23,5	28,4	50	1000
29	OSUV 29	29	34,5	25	1000
36	OSUV 36	36	42,5	25	500
48	OSUV 48	48	54,5	25	500



### TEKNİK ÖZELLİK

GES uygulamalarında kullanılan plastikler ciddi hava etkilerine maruz kalabilir. Bu uygulamalar genellikle, plastiklerin görünümüne ve mekanik özelliklerine etki edebilen ultraviyole ışınlarının olumsuz etkisine dayanabilen, hava koşullarına dayanıklı plastik malzemeye ihtiyaç duyar. Projede kullanılan spirallerin UV dirençli özellikte olması gerekmektedir. GES projelerinin olduğu bölgelerdeki ani hava ısı değişkenliklerine de (-/+ ) dikkat edilmesi gerekmektedir. ISO 4892-2 -3. Çevrim tipine göre yapılan 1000 saatlik UV ve ısı yaşlandırma testi yapılmakta üründe Ortadoğu Asya kıtası bölgelerindeki iklim koşullarına göre kıyaslandığında, belirtilen bölgelerde 4 yıllık süre içerisinde ürün renklerinde değişiklik olmadığı ortaya çıkmaktadır.

### UV dirençli plastiklerin görünümünde kendiliğinden aşağıdaki gibi bir değişiklik görülmez:

- Plastiğin sararması
- Boyalı plastiklerin sızdırması
- Plastik yüzeyinin beyazlaşması
- Gerilim çatlağı oluşumu

### Aynı zamanda mekanik özelliklerde aşağıdaki gibi değişiklikler olmaz:

- Kırılganlık gelişimi
- Dayanım, esneklik ve sertlik azalması
- Gerilim çatlağı oluşumu

### ÜRÜN SEÇİM CETVELİ

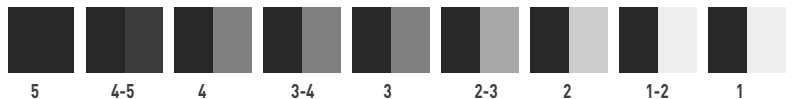
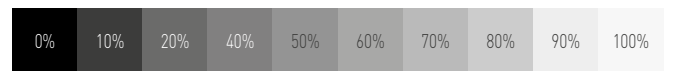

Gray scale for determining color differences

## SİRAL BORU & AKSESUARLARI

### POLYAMİD SİRAL BORULAR



Anma Çapı	Gri Kod	Siyah Kod	İç Çap mm	Dış Çap mm	Ambalaj Miktarı	Birim Fiyatı Euro
7	OGPA 7	OSPA 7	7	10	100	<b>0,49</b>
8,5	OGPA 8,5	OSPA 8,5	8,5	12	100	<b>0,54</b>
9	OGPA 9	OSPA 9	10	13	100	<b>0,63</b>
11	OGPA 11	OSPA 11	12	15,8	50	<b>0,86</b>
13,5	OGPA 13,5	OSPA 13,5	14,2	18,4	50	<b>0,96</b>
16	OGPA 16	OSPA 16	16,5	21,4	50	<b>1,21</b>
21	OGPA 21	OSPA 21	23,5	28,4	50	<b>1,71</b>
29	OGPA 29	OSPA 29	29	34,5	25	<b>2,24</b>
36	OGPA 36	OSPA 36	36	42,5	25	<b>2,84</b>
48	OGPA 48	OSPA 48	48	54,5	25	<b>4,45</b>

### POLİPROPİLİN SİRAL BORULAR



7	OGPP 7	OSPP 7	7	10	100	<b>0,31</b>
8,5	OGPP 8,5	OSPP 8,5	8,5	12	100	<b>0,36</b>
9	OGPP 9	OSPP 9	10	13	100	<b>0,41</b>
11	OGPP 11	OSPP 11	12	15,8	50	<b>0,44</b>
13,5	OGPP 13,5	OSPP 13,5	14,2	18,4	50	<b>0,59</b>
16	OGPP 16	OSPP 16	16,5	21,4	50	<b>0,64</b>
21	OGPP 21	OSPP 21	23,5	28,4	50	<b>0,90</b>
29	OGPP 29	OSPP 29	29	34,5	25	<b>1,09</b>
36	OGPP 36	OSPP 36	36	42,5	25	<b>1,41</b>
48	OGPP 48	OSPP 48	48	54,5	25	<b>2,30</b>

### POLYAMİD YARIKLI SİRAL BORULAR



7	OGPAY 7	OSPAY 7	7	10	100	<b>0,60</b>
8,5	OGPAY 8,5	OSPAY 8,5	8,5	12	100	<b>0,67</b>
9	OGPAY 9	OSPAY 9	10	13	100	<b>0,79</b>
11	OGPAY 11	OSPAY 11	12	15,8	50	<b>1,13</b>
13,5	OGPAY 13,5	OSPAY 13,5	14,2	18,4	50	<b>1,19</b>
16	OGPAY 16	OSPAY 16	16,5	21,4	50	<b>1,51</b>
21	OGPAY 21	OSPAY 21	23,5	28,4	50	<b>2,14</b>
29	OGPAY 29	OSPAY 29	29	34,5	25	<b>2,81</b>
36	OGPAY 36	OSPAY 36	36	42,5	25	<b>3,54</b>
48	OGPAY 48	OSPAY 48	48	54,5	25	<b>5,84</b>

### POLİPROPİLİN YARIKLI SİRAL BORULAR



7	OGPPY 7	OSPPY 7	7	10	100	<b>0,39</b>
8,5	OGPPY 8,5	OSPPY 8,5	8,5	12	100	<b>0,46</b>
9	OGPPY 9	OSPPY 9	10	13	100	<b>0,53</b>
11	OGPPY 11	OSPPY 11	12	15,8	50	<b>0,56</b>
13,5	OGPPY 13,5	OSPPY 13,5	14,2	18,4	50	<b>0,74</b>
16	OGPPY 16	OSPPY 16	16,5	21,4	50	<b>0,81</b>
21	OGPPY 21	OSPPY 21	23,5	28,4	50	<b>1,13</b>
29	OGPPY 29	OSPPY 29	29	34,5	25	<b>1,36</b>
36	OGPPY 36	OSPPY 36	36	42,5	25	<b>1,78</b>
48	OGPPY 48	OSPPY 48	48	54,5	25	<b>2,88</b>

### OVAL SİRAL BORU- POLYAMİD & PP



Gri Kod RAL 7031	Siyah Kod RAL 9005	Dış Çap En Ø mm.	Yükseklik İç çAp En Ø mm.	Yükseklik Dış çAp boy Ø mm.	Yükseklik İç çAp boy Ø mm.	Et Kalınlık Ø mm.	Ambalaj Miktarı mt.	Birim Fiyatı Euro
OGPA 2034	OSPA 2034	39,5	24,5	34,8	20,6	2,5	100	<b>3,60</b>
OGPP 2034	OSPP 2034	39,5	24,5	34,8	20,6	2,5	100	<b>2,40</b>



## SİRAL BORU & AKSESUARLARI

### PG DİŞ GEÇMELİ TİP SİRAL RAKORLAR

Gri Kod	Siyah Kod	Spiral Kod	Spiral Ölçü mm	Kutu Adeti	Birim Fiyatı Euro
ODG10-PG7	ODB10-PG7	OGPA 7	6,5 x 10	100	0,42
ODG12-PG7	ODB12-PG7	OGPA 8,5	8,5 x 12	75	0,42
ODG13-PG9	ODB13-PG9	OGPA 9	10 x 13	50	0,43
ODG15-PG11	ODB15-PG11	OGPA 11	12 x 15,8	50	0,50
ODG18-PG13,5	ODB18-PG13,5	OGPA 13,5	14,2 x 18,4	75	0,57
ODG21-PG16	ODB21-PG16	OGPA 16	16,5 x 21,2	50	0,72
ODG28-PG21	ODB28-PG21	OGPA 21	23,5 x 28,4	25	1,16
ODG34-PG29	ODB34-PG29	OGPA 29	29 x 34,5	20	1,49
ODG42-PG36	ODB42-PG36	OGPA 36	36 x 42,5	15	2,05
ODG54-PG48	ODB54-PG48	OGPA 48	48 x 54,5	10	2,75

### ÖZEL BOY PG DİŞ GEÇMELİ TİP SİRAL RAKORLAR

ODG13-PG7	ODB13-PG7	OGPA 9	10 x 13	50	0,51
ODG13-PG11	ODB13-PG11	OGPA 9	10 x 13	50	0,53
ODG13-PG13,5	ODB13-PG13,5	OGPA 9	10 x 13	50	0,56
ODG15-PG9	ODB15-PG9	OGPA 11	12 x 15,8	50	0,64
ODG15-PG13,5	ODB15-PG13,5	OGPA 11	12 x 15,8	50	0,64
ODG18-PG9	ODB18-PG9	OGPA 13,5	14,2 x 18,4	75	0,74
ODG18-PG11	ODB18-PG11	OGPA 13,5	14,2 x 18,4	75	0,74
ODG21-PG13,5	ODB21-PG13,5	OGPA 16	16,5 x 21,2	50	0,85

### METRİK DİŞ GEÇMELİ TİP SİRAL RAKORLAR

ODG10-M12	ODB10-M12	OGPA 7	6,5 x 10	100	0,43
ODG12-M12	ODB12-M12	OGPA 8,5	8,5 x 12	75	0,43
ODG13-M16	ODB13-M16	OGPA 9	10 x 13	50	0,47
ODG15-M16	ODB15-M16	OGPA 11	12 x 15,8	50	0,56
ODG18-M20	ODB18-M20	OGPA 13,5	14,2 x 18,4	75	0,64
ODG21-M20	ODB21-M20	OGPA 16	16,5 x 21,2	50	0,84
ODG28-M25	ODB28-M25	OGPA 21	23,5 x 28,4	25	1,34
ODG34-M32	ODB34-M32	OGPA 29	29 x 34,5	20	2,26
ODG42-M40	ODB42-M40	OGPA 36	36 x 42,5	15	3,08
ODG54-M63	ODB54-M63	OGPA 48	48 x 54,5	10	4,07

### ÖZEL BOY METRİK DİŞ GEÇMELİ TİP SİRAL RAKORLAR

ODG13-M12	ODB13-M12	OGPA 9	10 x 13	50	0,51
ODG13-M20	ODB13-M20	OGPA 9	10 x 13	50	0,56
ODG18-M16	ODB18-M16	OGPA 13,5	14,2 x 18,4	75	0,64
ODG15-M20	ODB15-M20	OGPA 11	12 x 15,8	50	0,74
ODG21-M25	ODB21-M25	OGPA 16	16,5 x 21,2	50	0,85
ODG28-M32	ODB28-M32	OGPA 21	23,5 x 28,4	25	1,60
ODG34-M40	ODB34-M40	OGPA 29	29 x 34,5	20	2,48
ODG42-M50	ODB42-M50	OGPA 36	36 x 42,5	15	3,36
ODG54-M50	ODB54-M50	OGPA 48	48 x 54,5	10	4,24

### PG DİŞ GEÇMELİ TİP SİRAL 90° DİRSEK RAKORLAR

ODDG10-PG7	ODDB10-PG7	OGPA 7	6,5 x 10	75	1,65
ODDG13-PG9	ODDB13-PG9	OGPA 9	10 x 13	50	1,87
ODDG15-PG11	ODDB15-PG11	OGPA 11	12 x 15,8	50	2,02
ODDG18-PG13,5	ODDB18-PG13,5	OGPA 13,5	14,2 x 18,4	50	2,45
ODDG21-PG16	ODDB21-PG16	OGPA 16	16,5 x 21,2	40	2,86
ODDG28-PG21	ODDB28-PG21	OGPA 21	23,5 x 28,4	20	3,28
ODDG34-PG29	ODDB34-PG29	OGPA 29	29 x 34,5	15	6,99
ODDG42-PG36	ODDB42-PG36	OGPA 36	36 x 42,5	5	9,46
ODDG54-PG48	ODDB54-PG48	OGPA 48	48 x 54,5	5	11,79

### METRİK

ODDG10-M12	ODDB10-M12	OGPA 7	6,5 x 10	75	1,65
ODDG13-M16	ODDB13-M16	OGPA 9	10 x 13	50	1,87
ODDG15-M16	ODDB15-M16	OGPA 11	12 x 15,8	50	2,02
ODDG18-M20	ODDB18-M20	OGPA 13,5	14,2 x 18,4	50	2,45
ODDG21-M20	ODDB21-M20	OGPA 16	16,5 x 21,2	40	2,86
ODDG28-M25	ODDB28-M25	OGPA 21	23,5 x 28,4	20	3,28



## SİRAL BORU & AKSESUARLARI

### PG-METRİK DIŞ GEÇMELİ TİP KABLO TUTUCU SİRAL RAKORLARI



PG Siyah Kod	Metrik Siyah Kod	Spiral Kod	Sıkma Aralığı	Kutu Adeti	PG Birim Fiyat €	Metrik Birim Fiyatı €
ODBR10-PG7	ODBR10-M12	OGPA 7	3,5-6	50	<b>0,65</b>	<b>0,71</b>
ODBR12-PG7	ODBR12-M12	OGPA 8,5	3,5-6	50	<b>0,65</b>	<b>0,71</b>
ODBR13-PG9	ODBR13-M16	OGPA 9	4,5-7	50	<b>0,72</b>	<b>0,79</b>
ODBR15-PG11	ODBR15-M16	OGPA 11	6-9	50	<b>0,86</b>	<b>0,94</b>
ODBR18-PG13,5	ODBR18-M20	OGPA 13,5	9-12	50	<b>0,98</b>	<b>1,08</b>
ODBR21-PG16	ODBR21-M20	OGPA 16	11-14	50	<b>1,21</b>	<b>1,33</b>
ODBR28-PG21	ODBR28-M25	OGPA 21	14-18	50	<b>1,86</b>	<b>2,04</b>
ODBR34-PG29	ODBR34-M32	OGPA 29	18-25	25	<b>2,56</b>	<b>2,82</b>
ODBR42-PG36	ODBR42-M40	OGPA 36	25-32	10	<b>3,77</b>	<b>4,15</b>

### POLYAMİD KAPAKLI KROŞELER



Gri Kod	Siyah Kod	Spiral Kod	Spiral Ölçü mm	Kutu Adeti	Birim Fiyatı €
ODGK10	ODBK10	OGPA 7	10	50	<b>0,26</b>
ODGK13	ODBK13	OGPA 9	13	50	<b>0,28</b>
ODGK15	ODBK15	OGPA 11	15,8	50	<b>0,29</b>
ODGK18	ODBK18	OGPA 13,5	18,4	50	<b>0,32</b>
ODGK21	ODBK21	OGPA 16	21,2	50	<b>0,37</b>
ODGK28	ODBK28	OGPA 21	28,4	25	<b>0,39</b>
ODGK34	ODBK34	OGPA 29	34,5	25	<b>0,68</b>
ODGK42	ODBK42	OGPA 36	42,5	25	<b>0,89</b>
ODGK54	ODBK54	OGPA 48	54,5	10	<b>1,02</b>

### POLYAMİD T - Y DAĞITICI ELEMANLARI (HER YÖNE)



Siyah Kod	Spiral Ölçü mm	Kutu Adeti	Birim Fiyatı €
ODBYT101010	9/9/9	<b>10</b>	<b>16,44</b>
ODBYT121212	11/11/11	10	<b>16,44</b>
ODBYT121010	11/9/9	10	<b>16,44</b>
ODBYT121010	16/16/16	10	<b>16,44</b>
ODBYT171212	16/11/11	10	<b>16,44</b>
ODBYT171010	16/9/9	10	<b>16,44</b>
ODBYT231717	21/16/16	10	<b>32,11</b>

### POLYAMİD T DAĞITICI ELEMANLARI



Siyah Kod	Spiral Ölçü mm	Kutu Adeti	Birim Fiyatı €
ODBT121212	9/9/9	10	<b>6,96</b>
ODBT161212	11/9/9	10	<b>7,41</b>
ODBT161216	11/9/11	10	<b>7,41</b>
ODBT161612	11/11/9	10	<b>7,41</b>
ODBT161616	11/11/11	10	<b>7,41</b>
ODBT201216	16/9/11	10	<b>8,69</b>
ODBT201616	16/11/11	10	<b>8,69</b>
ODBT201620	16/11/16	10	<b>8,69</b>
ODBT202016	16/16/11	10	<b>8,69</b>
ODBT202020	16/16/16	10	<b>9,41</b>
ODBT281620	21/11/16	10	<b>12,82</b>
ODBT282020	21/16/16	10	<b>12,82</b>
ODBT281628	21/11/21	10	<b>12,82</b>
ODBT282028	21/16/21	10	<b>12,82</b>
ODBT282828	21/21/21	10	<b>12,82</b>
ODBT321632	29/11/29	10	<b>16,45</b>
ODBT322032	29/16/29	10	<b>16,45</b>

### POLYAMİD Y DAĞITICI ELEMANLARI



Siyah Kod	Spiral Ölçü mm	Kutu Adeti	Birim Fiyatı €
ODBY121212	9/9/9	10	<b>7,06</b>
ODBY161212	11/9/9	10	<b>7,54</b>
ODBY161208	11/9/6	10	<b>7,54</b>
ODBY161608	11/11/6	10	<b>7,54</b>
ODBY201212	16/9/9	10	<b>8,96</b>
ODBY201612	16/11/9	10	<b>8,96</b>
ODBY202012	16/16/9	10	<b>8,96</b>
ODBY202016	16/16/11	10	<b>8,96</b>
ODBY282012	21/16/9	10	<b>13,04</b>
ODBY282016	21/16/11	10	<b>13,04</b>
ODBY282812	21/21/9	10	<b>13,04</b>
ODBY282816	21/21/11	10	<b>13,04</b>
ODBY282828	21/21/21	10	<b>13,04</b>



## SPIRAL BORU & AKSESUARLARI

### SENSÖR RAKORLARI

Siyah Kod	Spiral Kod	Metrik Dış	Birim Fiyatı €
ODBS-10M08	OSPA7	M 8 x 1	8,63
ODBS-10M12	OSPA9	M 12 x 1	8,63
ODBS-10M18	OSPA9	M 18 x 1	8,63
ODBS-10M30	OSPA9	M 30 x 1,5	9,35



### FLANŞLI RAKORLAR

ODBF-16	OSPA16	10	7,19
ODBF-21	OSPA21	10	10,79
ODBF-29	OSPA29	10	16,18
ODBF-36	OSPA36	10	24,28
ODBF-48	OSPA48	10	33,39



### MATUFLESS PVC DİŞLİ SPIRAL BORU GRİ/SİYAH

Gri Kod	İç Çap mm	Dış Çap mm	Ambalaj Miktarı	Birim Fiyatı €
GGX 8	8	12	03	1,53
GGX 10	10	14,5	30	1,61
GGX 12	12	16,3	30	1,76
GGX 14	14	18,6	30	1,84
GGX 16	16	20,5	30	2,13
GGX 20	20	24,7	30	3,15
GGX 22	22	27	30	3,53
GGX 25	25	30,3	30	4,37
GGX 28	28	33,2	30	4,79
GGX 32	32	37,5	30	5,55
GGX 35	35	40,5	30	5,92
GGX 38	38	44,1	30	6,30
GGX 40	40	46,2	30	7,17
GGX 50	50	57	30	8,10



### ÇELİK TEL ÖRGÜLÜ POLYAMİD SPIRAL BORULAR

Anma Çapı	Gri Kod	Siyah Kod	İç Çap mm	Dış Çap mm	Ambalaj Miktarı	Birim Fiyatı €
7	CTPAG 7	CTPAS 7	7	11	100	4,14
8,5	CTPAG 8,5	CTPAS 8,5	8,5	13	100	4,91
9	CTPAG 9	CTPAS 9	10	14	100	5,37
11	CTPAG 11	CTPAS 11	12	16,8	50	6,64
13,5	CTPAG 13,5	CTPAS 13,5	14,2	19,4	50	7,68
16	CTPAG 16	CTPAS 16	16,5	21,4	50	9,05
21	CTPAG 21	CTPAS 21	23,5	29,4	50	12,14
29	CTPAG 29	CTPAS 29	29	35,5	25	14,95
36	CTPAG 36	CTPAS 36	36	43,5	25	18,51
48	CTPAG 48	CTPAS 48	48	55,5	25	24,73



### HALIYEN KÖRÜGE BORULAR

Oval koruge borularımız güvenilir bir şekilde, uygulama alanı kısıtlı alanlarda kablo koruma sağlar. Kablo tavalarında olduğu gibi uzun metrajlarda bile ekstra aparat masrafı gerektirmez.

Oval koruge borularımız boylamsal bir eksen etrafında ve eşit merkezli olarak üretildiğinden mükemmel bir esneklik ve ince duvar kalınlıklarında bile mekanik yüklemelere karşı dayanıklılık sağlar. Oval köruğe borularımız kablo kanallarının çalışma alanlarının kısıtlı olduğu yerlerde rahat ve maliyeti uygun montaj sağlar.

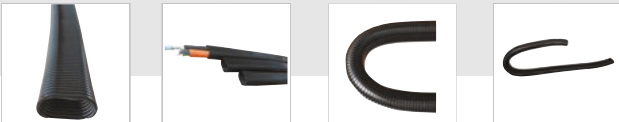

Malzeme: Polyamide 6 V2-V0  
 Material: Polyamide 6 V2-V0  
 Renk: RAL 7031 (gri) - RAL 9005 (siyah)  
 Color : RAL 7031 (grey) - RAL 9005 (black)  
 Çalışma sıcaklığı: -40+120c  
 Temperature Range: - 40+120c  
 Yanmazlık Sınıfı: UL94 V2-V0  
 Flammability Class: UL94 V2-V0  
 Özellik: UV ışınlarına dayanım  
 Prooertures: Halogen free  
 Yüksek darbe mukavemeti  
 DIN 55442 için sürekli titreşim  
 Solvent ve yağlara karşı çok dayanıklı



\*Bakınız sayfa: 38



## SİRAL BORU & AKSESUARLARI

### GALVANİZ SİRAL BORULAR



Kod	Ölçü mm	Ambalaj Miktarı	Birim Fiyatı TL
OCS 7	7 x 10,5	50	5,93
OCS 9	9 x 12	50	5,93
OCS 10	10 x 13 1/4"	50	6,85
OCS 11	11 x 14	50	6,97
OCS 13	13 x 16 3/8"	50	7,39
OCS 14	14 x 17	50	7,75
OCS 16	16 x 19 1/2"	50	8,96
OCS 18	18 x 21	50	10,22
OCS 21	21 x 24 3/4"	50	11,72
OCS 26	26 x 29 1"	25	15,44
OCS 29	29 x 33	25	18,25
OCS 32	32 x 36	25	20,24
OCS 35	35 x 39 1-1/4"	25	24,11
OCS 37	37 x 41	25	26,73
OCS 40	40 x 44 1-1/2"	25	28,71
OCS 42	42 x 46	25	30,21
OCS 45	45 x 49	25	31,95
OCS 51	51 x 55 2"	25	35,88
OCS 63	63 x 67 2-1/2"	25	Fiyat İsteyiniz
OCS 75	75 x 80 3"	25	Fiyat İsteyiniz

### PVC KAPLI GALVANİZ SİRAL BORULAR



Kod	Ölçü mm	Ambalaj Miktarı	Birim Fiyatı TL
OPCS 7	7 x 11,5	50	8,33
OPCS 9	9 x 12,5	50	8,33
OPCS 10	10 x 13 1/4"	50	9,44
OPCS 11	11 x 15	50	9,44
OPCS 13	13 x 17 3/8"	50	10,64
OPCS 14	14 x 18	50	10,94
OPCS 16	16 x 20 1/2"	50	12,49
OPCS 18	18 x 22	50	13,85
OPCS 21	21 x 25 3/4"	50	17,53
OPCS 26	26 x 31 1"	25	20,87
OPCS 29	29 x 34	25	25,03
OPCS 32	32 x 37	25	26,58
OPCS 35	35 x 40 1-1/4"	25	31,86
OPCS 37	37 x 42	25	33,55
OPCS 40	40 x 45 1-1/2"	25	40,91
OPCS 42	42 x 47	25	43,67
OPCS 45	45 x 50	25	45,75
OPCS 51	51 x 56 2"	25	51,37
OPCS 63	63 x 68 2-1/2"	15	Fiyat İsteyiniz
OPCS 75	75 x 83 3"	15	Fiyat İsteyiniz

### AĞIR HİZMET PVC KAPLI GALVANİZ SİRAL BORULAR



Kod	Ölçü mm	Ambalaj Miktarı	Birim Fiyatı USD
LGT 10	10 x 16 1/4"	30	4,75
LGT 12	13 x 18 3/8"	30	5,52
LGT 16	16 x 21 1/2"	30	6,47
LGT 21	21 x 26 3/4"	30	8,92
LGT 27	27 x 33 1"	30	12,10
LGT 35	35 x 42 1-1/4"	15	16,05
LGT 40	40 x 48 1-1/2"	15	19,90
LGT 51	52 x 60 2"	15	26,27
LGT 63	63 x 73 2-1/2"	7,5	42,11
LGT 78	78 x 88 3"	7,5	Fiyat İsteyiniz
LGT 102	102 x 114 4"	7,5	Fiyat İsteyiniz

- Ağır şartlara uygun
- Su geçirmez
- Kırılma önleyici mühür ipli

## SİRAL BORU & AKSESUARLARI

### TERMOPLASTİK TPV KAPLI GALVANİZ SİRAL BORULAR

1000 mt. ve üzeri üretilir.

Kod	Ölçü mm	Ambalaj Miktarı	Birim Fiyatı TL	
OPCHF 7	7 x 10,5	1/4"	50	15,09
OPCHF 9	9 x 12,5	3/8"	50	18,11
OPCHF 11	11 x 15		50	22,58
OPCHF 14	14 x 18		50	25,15
OPCHF 16	16 x 20	1/2"	50	28,62
OPCHF 18	18 x 22		50	32,16
OPCHF 21	21 x 25	3/4"	50	34,35
OPCHF 26	26 x 31	1"	25	47,05
OPCHF 29	29 x 35		25	49,43
OPCHF 32	32 x 37		25	56,60
OPCHF 35	35 x 40	1-1/4"	25	59,72
OPCHF 37	37 x 42		25	66,62
OPCHF 40	40 x 45	1-1/2"	25	76,00
OPCHF 42	42 x 47		25	77,25
OPCHF 45	45 x 50		25	88,80
OPCHF 50	51 x 56	2"	25	118,43

Halogen Free



### KILAVUZ TELLİ GALVANİZ SİRAL BORULAR

Kod	Ölçü mm	Ambalaj Miktarı	Birim Fiyatı TL	
OCS11K	11 x 14	3/8"	50	9,76
OCS14K	14 x 17		50	10,85
OCS16K	16 x 19	1/2"	50	12,54
OCS18K	18 x 21		50	14,30
OCS21K	21 x 24	3/4"	50	16,40
OCS26K	26 x 30	1"	25	21,62
OCS29K	29 x 33		25	25,55
OCS37K	37 x 41	1-1/4"	25	37,42
OCS42K	42 x 46		25	42,30
OCS51K	51 x 55	2"	25	50,23



### KILAVUZ TELLİ PVC KAPLI GALVANİZ SİRAL BORULAR

Kod	Ölçü mm	Ambalaj Miktarı	Birim Fiyatı TL	
OPCS11K	11 x 15	3/8"	50	13,21
OPCS14K	14 x 18		50	15,32
OPCS16K	16 x 20	1/2"	50	17,49
OPCS18K	18 x 22		50	19,39
OPCS21K	21 x 25	3/4"	50	24,54
OPCS26K	26 x 31	1"	25	29,21
OPCS29K	29 x 34		25	35,04
OPCS37K	37 x 42	1-1/4"	25	46,97
OPCS42K	42 x 47		25	61,14
OPCS51K	51 x 56	2"	25	71,92



### ÇELİK TEL ÖRGÜLÜ GALVANİZ SİRAL BORULAR

Kod	Ölçü mm	Ambalaj Miktarı	Birim Fiyatı TL	
CTS 10	10 x 15	1/4"	50	49,09
CTS 13	13 x 17,5	3/8"	50	59,79
CTS 16	16 x 21	1/2"	50	72,10
CTS 21	21 x 26	3/4"	50	91,62
CTS 26	26 x 31	1"	25	112,49
CTS 35	35 x 41	1-1/4"	25	155,89
CTS 40	40 x 46	1-1/2"	25	177,95
CTS 51	51 x 57	2"	25	222,43



### ÇELİK TEL ÖRGÜLÜ PVC KAPLI GALVANİZ SİRAL BORULAR

Kod	Ölçü mm	Ambalaj Miktarı	Birim Fiyatı TL	
CTPS 10	10 x 16	1/4"	50	52,36
CTPS 13	13 x 18,5	3/8"	50	66,88
CTPS 16	16 x 22	1/2"	50	80,12
CTPS 21	21 x 27	3/4"	50	102,79
CTPS 26	26 x 32	1"	25	126,26
CTPS 35	35 x 42	1-1/4"	25	169,72
CTPS 40	40 x 47	1-1/2"	25	197,93
CTPS 51	51 x 58	2"	25	246,95



## SİRAL BORU & AKSESUARLARI

### PİRİNÇ SİRAL BORU RAKORLARI (Somunsuz)

	PG Kod	PG Dış	Metrik Kod	Metrik Dış	Gas Kod	Gas Dış	Spiral Ölçü mm	Birim Fiyat TL
<b>SABİT TİP-IP 55</b>	MPR 7	PG 7	MMR 12	M 12	MGR 14	1/4"	OPCS7	<b>14,25</b>
	MPR 9	PG 9	MMR 16	M 16	MGR 38	3/8"	OPCS9	<b>15,89</b>
	MPR 11	PG 11	MMR 116	M 16	MGR 138	3/8"	OPCS11	<b>19,19</b>
	MPR 13,5	PG 13,5	MMR 20	M 20	MGR 12	1/2"	OPCS14	<b>22,67</b>
	MPR 16	PG 16	MMR 120	M 20	MGR 122	1/2"	OPCS16	<b>22,67</b>
	MPR 21	PG 21	MMR 25	M 25	MGR 34	3/4"	OPCS21	<b>31,67</b>
	MPR 29	PG 29	MMR 32	M 32	MGR 100	1"	OPCS26	<b>59,09</b>
	MPR 36	PG 36	MMR 40	M 40	MGR 114	1 1/4"	OPCS35	<b>90,67</b>
	MPR 42	PG 42	MMR 50	M 50	MGR 112	1 1/2"	OPCS40	<b>124,82</b>
	MPR 48	PG 48	MMR 63	M 63	MGR 200	2"	OPCS51	<b>143,86</b>
<b>DÖNER TİP-IP 55</b>	MDP 7	PG 7	MDM 12	M 12	MDG 14	1/4"	OPCS7	<b>16,95</b>
	MDP 9	PG 9	MDM 16	M 16	MDG 38	3/8"	OPCS9	<b>20,34</b>
	MDP 11	PG 11	MDM 116	M 16	MDG 138	3/8"	OPCS11	<b>23,73</b>
	MDP 13,5	PG 13,5	MDM 20	M 20	MDG 12	1/2"	OPCS14	<b>29,06</b>
	MDP 16	PG 16	MDM120	M 20	MDG 122	1/2"	OPCS16	<b>30,61</b>
	MDP 21	PG 21	MDM 25	M 25	MDG 34	3/4"	OPCS21	<b>50,95</b>
	MDP 29	PG 29	MDM 32	M 32	MDG 100	1"	OPCS26	<b>65,88</b>
	MDP 36	PG 36	MDM 40	M 40	MDG 114	1 1/4"	OPCS35	<b>113,34</b>
	MDP 42	PG 42	MDM 50	M 50	MDG 112	1 1/2"	OPCS40	<b>138,23</b>
	MDP 48	PG 48	MDM 63	M 63	MDG 200	2"	OPCS51	<b>200,53</b>

### HARİCİ TİP PİRİNÇ SİRAL BORU RAKORLARI (Somunsuz)

	PG Kod	PG Dış	Metrik Kod	Metrik Dış	NPT Kod	NPT Dış	Spiral Ölçü mm	Birim Fiyat TL
<b>SABİT TİP - IP67</b>	LSRP 00	PG 7	LSRM 00	12 x 1,5	LSRN 00	1/4"	LGT10	<b>27,02</b>
	LSRP 01A	PG 9	LSRM 1A	16 x 1,5	LSRN 1A	3/8"	LGT10	<b>27,03</b>
	LSRP 01	PG 11	LSRM 01	16 x 1,5	LSRN 01	3/8"	LGT13	<b>27,03</b>
	LSRP 2A	PG 13,5	-	-	-	-	LGT16	<b>30,61</b>
	LSRP 02	PG 16	LSRM 02	20 x 1,5	LSRN 02	1/2"	LGT16	<b>30,61</b>
	LSRP 03	PG 21	LSRM 03	25 x 1,5	LSRN 03	3/4"	LGT21	<b>43,61</b>
	LSRP 04	PG 29	LSRM 04	32 x 1,5	LSRN 04	1"	LGT26	<b>76,32</b>
	LSRP 05	PG 36	LSRM 05	40 x 1,5	LSRN 05	1 1/4"	LGT35	<b>99,84</b>
	LSRP 06	PG 42	LSRM 06	50 x 1,5	LSRN 06	1 1/2"	LGT40	<b>164,57</b>
	LSRP 07	PG 48	LSRM 07	63 x 1,5	LSRN 07	2"	LGT51	<b>282,85</b>
<b>DÖNER TİP</b>	LSRDP 00	PG 7	LSRDM 00	12 x 1,5	LSRDN 00	1/4"	LGT10	<b>32,08</b>
	LSRDP 01A	PG 9	LSRDM 1A	16 x 1,5	LSRDN 1A	1/4"	LGT10	<b>32,08</b>
	LSRDP 01	PG 11	LSRDM 01	16 x 1,5	LSRDN 01	3/8"	LGT13	<b>34,08</b>
	LSRDP 2A	PG 13,5	-	-	-	-	LGT16	<b>39,74</b>
	LSRDP 02	PG 16	LSRDM 02	20 x 1,5	LSRDN 02	1/2"	LGT16	<b>39,74</b>
	LSRDP 03	PG 21	LSRDM 03	25 x 1,5	LSRDN 03	3/4"	LGT21	<b>57,71</b>
	LSRDP 04	PG 29	LSRDM 04	32 x 1,5	LSRDN 04	1"	LGT26	<b>97,29</b>
	LSRDP 05	PG 36	LSRDM 05	40 x 1,5	LSRDN 05	1 1/4"	LGT35	<b>136,68</b>
	LSRDP 06	PG 42	LSRDM 06	50 x 1,5	LSRDN 06	1 1/2"	LGT40	<b>210,27</b>
	LSRDP 07	PG 48	LSRDM 07	63 x 1,5	LSRDN 07	2"	LGT51	<b>341,31</b>

### HARİCİ TİP KABLO TUTUCULU SİRAL RAKORU (Somunsuz)- IP67

	PG Kod	Ölçü	Spiral Ölçü	Kablo Sıkma Aralığı	Birim Fiyat
<b>PG</b>	MLSRP 1A	PG 9	10 - 1/4"	4-8	
	MLSRP 01	PG 11	13 - 3/8"	5-10	
	MLSRP 2A	PG 13,5	16 - 1/2"	6-12	
	MLSRP 02	PG 16	16 - 1/2"	10-14	
	MLSRP 03	PG 21	21 - 3/4"	13-18	
	MLSRP 04	PG 29	26 - 1"	18-25	
	MLSRP 05	PG 36	35 - 1 1/4"	22-32	
	MLSRP 06	PG 42	40 - 1 1/2"	30-38	
	MLSRP 07	PG 48	51 - 2"	34-44	
	<b>METRİK</b>	MLSRM 1A	M 16 X 1,5	10 - 1/4"	4-8
MLSRM01		M 16 X 1,5	13 - 3/8"	4-8	
MLSRM 02		M 20 X 1,5	16 - 1/2"	6-12	
MLSRM 03		M 25 X 1,5	21 - 3/4"	10-14	
MLSRM 04		M 32 X 1,5	26 - 1"	13-18	
MLSRM 05		M 40 X 1,5	35 - 1 1/4"	18-25	
MLSRM 06		M 50 X 1,5	40 - 1 1/2"	22-32	
MLSRM 07	M 63 X 1,5	51 - 2"	34-44		

• Kablo Sıkmalı Model



## SİRAL BORU & AKSESUARLARI

### ÇELİK TEL ÖRGÜLÜ POLYAMİD SİRAL RAKORLARI (Somunsuz)

PG Kod	Metrik Kod	Spiral Ölçü Dış Çap / mm	Birim Fiyatı
LSRPAG-13-PG9	LSRPAG-13-M16	13	
LSRPAG-15-PG11	LSRPAG-15-M16	15,8	
LSRPAG-18-PG13,5	LSRPAG-18-M20	18	
LSRPAG-21-PG16	LSRPAG-21-M20	21	
LSRPAG-28-PG21	LSRPAG-28-M25	28	
LSRPAG-34-PG29	LSRPAG-34-M32	34	
LSRPAG-42-PG36	LSRPAG-42-M40	42	
LSRPAG-54-PG48	LSRPAG-54-M63	54	
LSRDPAG-13-PG9	LSRDPAG-13-M16	13	
LSRDPAG-15-PG11	LSRDPAG-15-M16	15,8	
LSRDPAG-18-PG13,5	LSRDPAG-18-M20	18	
LSRDPAG-21-PG16	LSRDPAG-21-M20	21	
LSRDPAG-28-PG21	LSRDPAG-28-M25	28	
LSRDPAG-34-PG29	LSRDPAG-34-M32	34	
LSRDPAG-42-PG36	LSRDPAG-42-M40	42	
LSRDPAG-54-PG48	LSRDPAG-54-M63	54	

Sabit Tip

Döner Tip



\* İstenilen ölçüde özel üretilebilir. • Polyamid Spiral üzeri tel örgülü modele uygundur.

### PG SİRAL BORU RAKORLARI

Kod	Ölçü	Uygun Spiral	Ambalaj Miktarı	Birim Fiyatı TL
OHB 01	PG 7	OPCS 9	400	1,58
OHB 02	PG 9	OPCS 11	300	1,68
OHB 03	PG 11	OPCS 14	200	2,06
OHB 04	PG 13,5	OPCS 16	150	2,30
OHB 05	PG 16	OPCS 18	125	2,46
OHB 06	PG 21	OPCS 23	75	3,64
OHB 07	PG 29	OPCS 32	40	4,78
OHB 08	PG 36	OPCS 40	30	10,59
OHB 09	PG 48	OPCS 51	15	14,43

### METRİK SİRAL BORU RAKORLARI

MHB Kod	MHB Ölçü	MHB Uygun Spiral	MHB Ambalaj Miktarı	MHB Birim Fiyatı TL
MHB 01	M 12	OPCS 9	400	2,00
MHB 02	M 16K	OPCS 11	300	2,15
MHB 03	M 16	OPCS 14	200	2,70
MHB 04	M 20	OPCS 16	150	3,03
MHB 05	M 20K	OPCS 18	125	3,26
MHB 06	M 25	OPCS 23	75	4,86
MHB 07	M 40	OPCS 32	40	6,38
MHB 08	M 50	OPCS 40	30	11,77
MHB 09	M 63	OPCS 51	15	14,41

### PVC ENTÜL (Sonlandırıcı)

KE Kod	KE Ölçü	KE Uygun Spiral	KE Ambalaj Miktarı	KE Birim Fiyatı TL
KE 01	1/2"	GBE-050	50	2,48
KE 02	3/4"	GBE-075	50	2,59
KE 03	1"	GBE-100	50	2,59
KE 04	1 1/4"	GBE-125	25	3,42
KE 05	1 1/2"	GBE-150	25	3,98
KE 06	2"	GBE-200	25	8,41

### P KLİPSLER

PKL Kod	PKL Ölçü	PKL Uygun Spiral	PKL Ambalaj Miktarı	PKL Birim Fiyatı TL
PKL 1	PG 7	OPCS 7	100	2,57
PKL 2	PG 9	OPCS 9	100	2,77
PKL 3	PG 11	OPCS 11	100	2,96
PKL 4	PG 13,5	OPCS 14	100	3,21
PKL 5	PG 16	OPCS 16	100	3,46
PKL 6	PG 21	OPCS 21	100	3,95
PKL 7	PG 29	OPCS 29	50	4,69
PKL 8	PG 36	OPCS 35	50	5,34
PKL 9	PG 48	OPCS 51	50	6,42



## HAREKETLİ KABLO TAŞIYICILARI

### HARAKETLİ KABLO KANALLARI

KOD	A İç yükseklik	B İç Genişlik	C Dış Yükseklik	D Dış Genişlik	R Kıvrılma Yarıçapı	Birim Fiyatı Euro
<b>OK 15 HAFİF SERİ - SABİT ÇİTALİ</b>						
OK15 F 015 R	15	15	20	23	25-35	<b>19,80</b>
OK15 F 020 R	15	20	20	28	25-35	<b>20,63</b>
OK15 F 030 R	15	30	20	38	25-35	<b>21,45</b>
OK15 F 040 R	15	40	20	48	25-35	<b>22,28</b>
<b>OK 15 HAFİF SERİ-İÇTEN AÇILIR ÇİTALİ</b>						
OK15 A 015 R	15	15	20	23	25-35	<b>28,05</b>
OK15 A 020 R	15	20	20	28	25-35	<b>28,88</b>
OK15 A 030 R	15	30	20	38	25-35	<b>29,70</b>
OK15 A 040 R	15	40	20	48	25-35	<b>30,55</b>
<b>OK 15 SERİSİ - DIŞTAN AÇILIR ÇİTALİ</b>						
OK15 B 015 R	15	15	20	23	25-35	<b>28,05</b>
OK15 B 020 R	15	20	20	28	25-35	<b>28,88</b>
OK15 B 030 R	15	30	20	38	25-35	<b>29,70</b>
OK15 B 040 R	15	40	20	48	25-35	<b>30,53</b>
<b>OK 15 SERİSİ AKSESUAR</b>						
OK15 P015			15x15 Plastik Ayak Bağlantı			<b>4,95</b>
OK15 P020			15x20 Plastik Ayak Bağlantı			<b>4,95</b>
OK15 P030			15x30 Plastik Ayak Bağlantı			<b>4,95</b>
OK15 P040			15x40 Plastik Ayak Bağlantı			<b>6,60</b>
<b>OK 20 SERİSİ AÇIK -YARI KAPALI SABİT ÇİTALİ</b>						
OK20 F 025 R040	20	25	26	37	40	<b>19,80</b>
OK20 Y 025 R040	20	25	26	37	40	<b>29,70</b>
OK20 Y 040 R040	20	40	26	52	40	<b>33,00</b>
OK20 Y 050 R040	20	50	26	62	40	<b>36,30</b>
OK20 Y 060 R040	20	60	26	72	40	<b>39,60</b>
<b>OK 20 SERİSİ AKSESUAR</b>						
OK20 P 025			20x25 Pastik Ayak Bağlantı			<b>6,60</b>
OK20 P 040			20x40 Pastik Ayak Bağlantı			<b>6,60</b>
OK20 P 050			20x50 Pastik Ayak Bağlantı			<b>8,25</b>
OK20 P 060			20x60 Pastik Ayak Bağlantı			<b>8,25</b>
<b>OK 24 AÇIK SERİSİ-SABİT ÇİTALİ</b>						
OK24 F 018 R...	24	25	32	37	40-75-100-125	<b>33,00</b>
OK24 F 025 R...	24	25	32	37	40-75-100-125	<b>34,65</b>
OK24 F 040 R...	24	40	32	52	40-75-100-125	<b>36,30</b>
OK24 F 48 R...	24	48	32	60	40-75-100-125	<b>37,95</b>
OK24 F 060 R	24	60	32	72	40-75-100-125	<b>39,60</b>
OK24 F 080 R...	24	80	32	92	40-75-100-125	<b>42,90</b>
<b>OK 24 AÇIK SERİSİ-İÇTEN AÇILIR ÇİTALİ</b>						
OK24 A 025 R...	24	25	32	39	40-75-100-125	<b>36,30</b>
OK24 A 040 R...	24	40	32	54	40-75-100-125	<b>39,60</b>
OK24 A 050 R...	24	50	32	64	40-75-100-125	<b>42,90</b>
OK24 A 060 R...	24	60	32	74	40-75-100-125	<b>46,20</b>

## HAREKETLİ KABLO TAŞIYICILARI

### HARAKETLİ KABLO KANALLARI

KOD	A İç yükseklik	B İç Genişlik	C Dış Yükseklik	D Dış Genişlik	R Kıvrılma Yarıçapı	Birim Fiyatı Euro
<b>OK 24 SERİSİ AKSESUAR</b>						
OK24 P 018			24x18 Pastik Ayak Bağlantı			<b>9,90</b>
OK24 P 025			24x25 Pastik Ayak Bağlantı			<b>9,90</b>
OK24 P 040			24x40 Pastik Ayak Bağlantı			<b>9,90</b>
OK24 P 050			24x50 Pastik Ayak Bağlantı			<b>9,90</b>
OK24 P 060			24x60 Pastik Ayak Bağlantı			<b>9,90</b>
OK24 P 080			24x80 Pastik Ayak Bağlantı			<b>9,90</b>
OK24 SP			24 Seperator			<b>0,33</b>
<b>OK 25 AÇIK SERİ</b>						
OK25 A 040 R...	25	40	42	62	40-75-100-125	<b>47,85</b>
OK25 A 050 R...	25	50	42	72	40-75-100-125	<b>49,50</b>
OK25 A 060 R...	25	60	42	82	40-75-100-125	<b>51,15</b>
OK25 A 080 R...	25	80	42	102	40-75-100-125	<b>54,45</b>
OK25 A 100 R...	25	100	42	122	40-75-100-125	<b>57,75</b>
<b>OK 25 SERİSİ AKSESUAR</b>						
OK25 P			25'lik Pastik Ayak Bağlantı			<b>9,90</b>
OK25 M			25'lik Metal Ayak Bağlantı			<b>14,85</b>
OK25 SP			25 Seperator			<b>0,33</b>
OK25 NP			25'lik Pastik Ayak Bağlantı (Yeni dizayn)			<b>14,85</b>
OK KS			Kablo Sabitleyici			<b>0,66</b>
<b>OK 30 AÇIK SERİ</b>						
OK30 A 040 R...	30	40	47	62	50-75-100-150	<b>52,80</b>
OK30 A 050 R...	30	50	47	72	50-75-100-150	<b>54,45</b>
OK30 A 060 R...	30	60	47	82	50-75-100-150	<b>56,10</b>
OK30 A 080 R...	30	80	47	102	50-75-100-150	<b>59,40</b>
OK30 A 100 R...	30	100	47	122	50-75-100-150	<b>62,70</b>
<b>OK 30 SERİSİ AKSESUAR</b>						
OK30 P			30'luk Pastik Ayak Bağlantı			<b>11,55</b>
OK30 M			30'luk Metal Ayak Bağlantı			<b>14,85</b>
OK30 SP			30 Seperator			<b>0,41</b>
OK30 NP			30'luk Pastik Ayak Bağlantı (Yeni dizayn)			<b>16,50</b>
OK KS			Kablo Sabitleyici			<b>0,66</b>
<b>OK 35 AÇIK SERİ</b>						
OK35 A 040 R...	35	40	52	64	50-75-100-150	<b>52,80</b>
OK35 A 050 R...	35	50	52	74	50-75-100-150	<b>54,45</b>
OK35 A 060 R...	35	60	52	84	50-75-100-150	<b>56,10</b>
OK35 A 080 R...	35	80	52	104	50-75-100-150	<b>59,40</b>
OK35 A 100 R...	35	100	52	124	50-75-100-150	<b>62,70</b>
OK35 A 120 R...	35	120	52	144	50-75-100-150	<b>66,00</b>
OK35 A 125 R...	35	125	52	149	50-75-100-150	<b>69,30</b>
OK35 A 175 R...	35	175	52	199	50-75-100-150	<b>75,90</b>
<b>OK 35 YARI KAPALI SERİ</b>						
OK35 Y 040 R...	35	40	52	64	75-100-150	<b>58,14</b>
OK35 Y 060 R...	35	60	52	84	75-100-150	<b>61,56</b>
OK35 Y 080 R...	35	80	52	104	75-100-150	<b>64,98</b>
OK35 Y 100 R...	35	100	52	124	100-150	<b>68,40</b>
OK35 Y 125 R...	35	125	52	149	100-150	<b>71,82</b>



## HAREKETLİ KABLO TAŞIYICILARI

### HAREKETLİ KABLO KANALLARI



KOD	A İç yükseklik	B İç Genişlik	C Dış Yükseklik	D Dış Genişlik	R Kıvrılma Yarıçapı	Birim Fiyatı Euro
<b>OK 35 KAPALI SERİ</b>						
OK35 K 040 R...	35	40	52	64	75-100-150	<b>58,14</b>
OK35 K 060 R...	35	60	52	84	75-100-150	<b>61,56</b>
OK35 K 080 R...	35	80	52	104	75-100-150	<b>64,98</b>
OK35 K 100 R...	35	100	52	124	100-150	<b>68,40</b>
OK35 K 125 R...	35	125	52	149	100-150	<b>71,82</b>

#### OK 35 SERİSİ AKSESUAR

OK35 P	35'lik Pastik Ayak Bağlantı					<b>13,20</b>
OK35 M	35'lik Metal Ayak Bağlantı					<b>17,40</b>
OK35 SP	35 Seperator					<b>0,41</b>
OK35 NP	35'lik Pastik Ayak Bağlantı (Yeni dizayn)					<b>19,80</b>
OK35 KS	Kablo Sabitleyici					<b>0,66</b>



<b>OK 40 AÇIK SERİ</b>						
OK40 A 080 R...	40	80	62	108	75-100-125-150-200-250-300	<b>87,36</b>
OK40 A 100 R...	40	100	62	128	75-100-125-150-200-250-300	<b>90,72</b>
OK40 A 120 R...	40	120	62	148	75-100-125-150-200-250-300	<b>94,08</b>
OK40 A 140 R...	40	140	62	168	75-100-125-150-200-250-300	<b>99,18</b>
OK40 A 160 R...	40	160	62	188	75-100-125-150-200-250-300	<b>102,60</b>
OK40 A 180 R...	40	180	62	208	75-100-125-150-200-250-300	<b>106,02</b>
OK40 A 200 R...	40	200	62	228	75-100-125-150-200-250-300	<b>110,40</b>

#### OK 40 KAPALI SERİ

OK40 K 100 R...	40	100	62	128	125-150-200--250-300	<b>115,50</b>
-----------------	----	-----	----	-----	----------------------	---------------

#### OK 40 YARI KAPALI SERİ

OK40 Y 100 R...	40	100	62	128	125-150-200--250-300	<b>115,50</b>
-----------------	----	-----	----	-----	----------------------	---------------

#### OK 40 AÇIK SERİ ALÜMİNYUM ÇITALI

OK40 AL 250 R...	40	250	62	278	75-100-125-150-200-250-300	<b>119,70</b>
OK40 AL 300 R...	40	300	62	328	75-100-125-150-200-250-300	<b>126,54</b>
OK40 AL 400 R...	40	400	62	428	75-100-125-150-200-250-300	<b>133,38</b>
OK40 AL 500 R...	40	500	62	528	75-100-125-150-200-250-300	<b>140,22</b>



#### OK 40 SERİSİ AKSESUAR

OK40 P	40'lık Pastik Ayak Bağlantı					<b>16,50</b>
OK40 M	40'lık Metal Ayak Bağlantı					<b>23,04</b>
OK40 SP	40 Seperator					<b>0,58</b>
OK 40 NP	40'lık Plastik Ayak Bağlantı (Yeni dizayn)					<b>26,40</b>
OK KS	Kablo Sabitleyici					<b>0,66</b>



<b>OK 42 AÇIK SERİ</b>						
OK42 A 040 R...	42	40	58	67	75-100-150-200	<b>56,10</b>
OK42 A 050 R...	42	50	58	77	75-100-150-200	<b>59,40</b>
OK42 A 060 R...	42	60	58	87	75-100-150-200	<b>62,70</b>
OK42 A 080 R...	42	80	58	107	75-100-150-200	<b>66,00</b>
OK42 A 100 R...	42	100	58	127	75-100-150-200	<b>69,30</b>
OK42 A 120 R...	42	120	58	147	75-100-150-200	<b>72,60</b>
OK42 A 125 R...	42	125	58	152	75-100-150-200	<b>75,90</b>
OK42 A 175 R...	42	175	58	202	75-100-150-200	<b>82,50</b>

#### OK 42 KAPALI SERİ

OK42 K 050 R...	42	50	58	77	100-150-200	<b>66,00</b>
OK42 K 080 R...	42	80	58	107	100-150-200	<b>74,25</b>
OK42 K 100 R...	42	100	58	127	100-150-200	<b>74,25</b>
OK42 K 125 R...	42	125	58	152	100-150-200	<b>90,75</b>



#### OK 42 YARI KAPALI SERİ

OK42 Y 050 R...	42	50	58	77	100-150-200	<b>66,00</b>
OK42 Y 080 R...	42	80	58	107	100-150-200	<b>74,25</b>
OK42 Y 100 R...	42	100	58	127	100-150-200	<b>74,25</b>
OK42 K 125 R...	42	125	58	152	100-150-200	<b>90,75</b>



## HAREKETLİ KABLO TAŞIYICILARI

### HARAKETLİ KABLO KANALLARI

KOD	A İç yükseklik	B İç Genişlik	C Dış Yükseklik	D Dış Genişlik	R Kıvrılma Yarıçapı	Birim Fiyatı Euro
<b>OK 42 SERİSİ AKSESUAR</b>						
OK42 P			42'lik Pastik Ayak Bağlantı			14,85
OK42 M			42'lik Metal Ayak Bağlantı			21,45
OK42 SP			42 Seperator			0,50
OK42 NP			42'lik Pastik Ayak Bağlantı ( Yeni dizayn )			21,45
OK42 KS			Kablo Sabitleyici			0,66
<b>OK 60 AÇIK SERİ</b>						
OK60 A 080 R...	60	80	82	112	100-150-200-250-300	102,30
OK60 A 100 R...	60	100	82	132	100-150-200-250-300	105,60
OK60 A 120 R...	60	120	82	152	100-150-200-250-300	108,90
OK60 A 140 R...	60	140	82	172	100-150-200-250-300	112,20
OK60 A 160 R...	60	160	82	192	100-150-200-250-300	115,50
OK60 A 180 R...	60	180	82	212	100-150-200-250-300	118,80
OK60 A 200 R...	60	200	82	232	100-150-200-250-300	122,10
<b>OK 60 YARI AÇIK SERİ</b>						
OK60 Y 100 R...	60	100	82	132	150-200-250-300	132,00
OK60 Y 140 R...	60	140	82	172	150-200-250-300	148,50
OK60 Y 200 R...	60	200	82	232	150-200-250-300	165,00
<b>OK 60 KAPALI SERİ</b>						
OK60 K 100 R...	60	100	82	132	150-200-250-300	132,00
OK60 K 140 R...	60	140	82	172	150-200-250-300	148,50
OK60 K 200 R...	60	200	82	232	150-200-250-300	165,00
<b>OK 60 ALÜMİNYUM ÇITALI</b>						
OK60 AL 250 R...	60	250	82	282	100-150-200-250-300	136,80
OK60 AL 300 R...	60	300	82	332	100-150-200-250-300	143,64
OK60 AL 400 R...	60	400	82	432	100-150-200-250-300	150,48
OK60 AL 500 R...	60	500	82	532	100-150-200-250-300	157,32
<b>OK 60 SERİSİ AKSESUAR</b>						
OK60 P			60'lık Pastik Ayak Bağlantı			18,15
OK60 M			60'lık Metal Ayak Bağlantı			31,20
OK60 SP			60 Seperator			0,66
OK60 NP			60'lık Plastik Ayak Bağlantı ( Yeni dizayn )			29,70
OK60 KS			Kablo Sabitleyici			0,66
<b>OK 80 AÇIK SERİ</b>						
OK80 A 080 R...	80	80	102	112	150-200-250-300	118,80
OK80 A 100 R...	80	100	102	132	150-200-250-300	122,10
OK80 A 120 R...	80	120	102	152	150-200-250-300	125,40
OK80 A 140 R...	80	140	102	172	150-200-250-300	128,70
OK80 A 160 R...	80	160	102	192	150-200-250-300	132,00
OK80 A 180 R...	80	180	102	212	150-200-250-300	135,30
OK80 A 200 R...	80	200	102	232	150-200-250-300	138,60
<b>OK 80 ALÜMİNYUM ÇITALI</b>						
OK80 AL 250 R...	80	250	102	282	150-200-250-300	148,50
OK80 AL 300 R...	80	300	102	332	150-200-250-300	155,10
OK80 AL 400 R...	80	400	102	432	150-200-250-300	161,70
OK80 AL 500 R...	80	500	102	532	150-200-250-300	168,30
<b>OK 80 SERİSİ AKSESUAR</b>						
OK80 M			80'lik Metal Ayak Bağlantı			36,90
OK80 SP			80 Seperator			0,83



## HAREKETLİ KABLO TAŞIYICILARI

### HAREKETLİ KABLO KANALLARI

KOD	A İç yükseklik	B İç Genişlik	C Dış Yükseklik	D Dış Genişlik	R Kıvrılma Yarıçapı	Birim Fiyatı
<b>ÖZEL İŞLEMELİ ALÜMİNYUM SERİSİ</b>						
<b>22 SERİ</b>						
OS22A	22	50-400	40	65-415	50-150	
OS22B	22	50-400	40	65-415	50-150	
OS22M				22'lik Çelik Ayak Bağlantı		
OS22SP				22 Seperator		
<b>OS 30 SERİ</b>						
OS30A	30	50-150	50	66-516	75-150	
OS30B	-	50-150	50	66-516	75-150	
OS30K	30	50-150	50	66-516	75-150	
OS30M				30'luk Çelik Ayak Bağlantı		
OS30SP				30 Seperator		
<b>OS 45 SERİ</b>						
OS45A	45	80-600	63	102-622	75-100-150-200-250	
OS45B	-	80-600	63	102-622	75-100-150-200-250	
OS45K	45	80-600	63	102-622	75-100-150-200-250	
OS45M				45'lik Çelik Ayak Bağlantı		
OS45SP				45 Seperator		
<b>OS 60 SERİ</b>						
OS60A	60	80-60	78	102-622	100-150-200-250-300-400	
OS60B	-	80-60	78	102-622	100-150-200-250-300-400	
OS60K	60	80-60	78	102-622	100-150-200-250-300-400	
OS60M				60'lik Çelik Ayak Bağlantı		
OS60SP				60 Seperator		
<b>OS 75 SERİ</b>						
OS75A	75	100-800	97	132-832	150-200-250-300-450	
OS75B	-	100-800	97	132-832	150-200-250-300-450	
OS75K	75	100-800	97	132-832	150-200-250-300-450	
OS75M				75'lik Çelik Ayak Bağlantı		
OS75SP				75 Seperator		
<b>OS 110 SERİ</b>						
OS110A	110	200-1000	145	232-1032	250-300-350-400-500-600-800-1000	
OS110B	-	200-1000	145	232-1032	250-300-350-400-500-600-800-1000	
OS110K	110	200-1000	145	232-1032	250-300-350-400-500-600-800-1000	
OS110M				110'luk Çelik Ayak Bağlantı		
OS110SP				110 Seperator		
<b>OS 180 SERİ</b>						
OS180A	180	250-1500	220	295-1545	400-500-600-700-800-900-1100-1400	
OS180B	-	250-1500	220	295-1545	400-500-600-700-800-900-1100-1400	
OS180K	180	250-1500	220	295-1545	400-500-600-700-800-900-1100-1400	
OS180M				180'lik Çelik Ayak Bağlantı		
OS180SP				180 Seperator		
<b>OS 250 SERİ</b>						
OS250M	250	250-1500	290	295-1545	500-600-700-800-900-1100-1400	
OS250B	-	250-1500	290	295-1545	500-600-700-800-900-1100-1400	
OS250K	250	250-1500	290	295-1545	500-600-700-800-900-1100-1400	
OS250M				250'lik Çelik Ayak Bağlantı		
OS250SP				250 Seperator		

- L** Kullanılacak Miktar  
Calculation of the chain length
- HM** Hareket Mesafesi  
Movement Distance
- Y** Radüs Mesafesi  
Radius Distance
- X** Montaj Yüksekliği  
Mounting Height
- H** Hatve  
Pitch

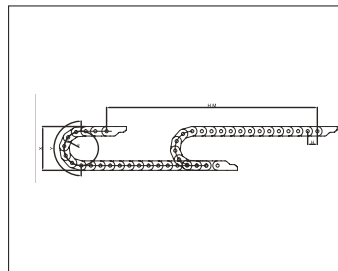

$$L = HM/2 + Y$$

$$X = Rx2 + C$$

$$Y = Rxn$$

- B** ..... ÇİTALARI DIŞTAN AÇILIR
- F** ..... SABİT ÇİTALI AÇILMAZ
- A** ..... ÇİTASI İÇTEN AÇILIR

- AL** ..... ALÜMİNYUM ÇİTALI
- K** ..... KOMPLE KAPALI KAPAK
- Y** ..... ALTI KAPALI ÜSTÜ ÇİTALI



# ORTAC®

## Kablo Taşıyıcı Sistemleri

# HAREKETLİ KABLO KANALLARI KATMADEĞERLİ ÜRETİM

Ortac Hareketli Kablo Kanalları ile  
kablotaşıma sistemlerinde ki  
dışa bağımlılığı azaltıyoruz.

Ürün seçimleri, özel üretimler için  
Ar-Ge ve teknik destek ile  
yanınızdayız.



- \* Hafif & Orta & Ağır & metal seri versiyonları
- \* Kablo ayırıcı seperatör-metal, plastik montaj ayakları
- \* Farklı uygulama alanlarında çok yönlü çözümler
- \* Kolay ve hızlı montaj
- \* Geniş ayırıcı seçicileri
- \* Aşırı yükler ve zorlu çevre koşullarında çalışma
- \* Stoktan teslim
- \* Uzun mesafe çalışabilme
- \* -40+130°C sıcaklıkta çalışabilme
- \* Yatay ve dikey eksenlerde çalışabilme
- \* Yüksek hız hareketlerinde ideal çözüm ve farklı seçenekler
- \* Kablonun kanal içinde dönüşünü engelleyici sistem
- \* Farklı ayak seçenekleri ile montaj çeşitliliği
- \* 7mm'den 80'mm kadar farklı iç yükseklik ölçüleri ile en küçük robotdan lazer makinelerine kadar geniş ürün yelpazesi

Hadımköy Mah. İbni Sina Cad. No:9 Arnavutköy / İSTANBUL  
T: +90 (212) 858-1900 | F: +90 (212) 858-1959

[www.ortacler.com.tr](http://www.ortacler.com.tr)



# ORTAC®

Kablo Bağlantı Elemanları



**EMT, IMC, RSC BORULAR & AKSESUARLARI**

*EMT, IMC, RSC CONDUITS & ACCESSORIES*

## EMT / IMC BORU & AKSESUARLARI

### EMT GALVANİZ BORULAR

ANSI C80.3 - UL 797

Kod	Ölçü	Dış Çap mm	Et Kalınlık	Ağırlık	Ambalaj	Rulo Boyu m.	Birim Fiyatı mt. \$
GBE-050	1/2"	17,9	0,80	1,36	10	3,00	Teklif İsteyiniz
GBE-075	3/4"	23,4	0,80	2,09	10	3,00	Teklif İsteyiniz
GBE-100	1"	29,5	1,00	3,04	10	3,00	Teklif İsteyiniz
GBE-125	1-1/4"	38,3	1,20	4,30	5	3,00	Teklif İsteyiniz
GBE-150	1-1/2"	44,2	1,50	5,20	5	3,00	Teklif İsteyiniz
GBE-200	2"	55,8	1,50	6,70	3	3,00	Teklif İsteyiniz



### VİDALI TİP EMT BORU - BUAT RAKORLARI

Kod	Ölçü	Kutu Adedi	Birim Fiyatı Adet \$
VBR 050	1/2"	50	Teklif İsteyiniz
VBR 075	3/4"	50	Teklif İsteyiniz
VBR 100	1"	50	Teklif İsteyiniz
VBR 125	1-1/4"	50	Teklif İsteyiniz
VBR 150	1-1/2"	50	Teklif İsteyiniz
VBR 200	2"	50	Teklif İsteyiniz



### VİDALI TİP EMT BORU - BİRLEŞTİRME MUFU

VBM 050	1/2"	50	Teklif İsteyiniz
VBM 075	3/4"	50	Teklif İsteyiniz
VBM 100	1"	50	Teklif İsteyiniz
VBM 125	1-1/4"	50	Teklif İsteyiniz
VBM 150	1-1/2"	50	Teklif İsteyiniz
VBM 200	2"	50	Teklif İsteyiniz



### SIKMALI TİP EMT BORU BUAT RAKORLARI

SBR 050	1/2"	50	Teklif İsteyiniz
SBR 075	3/4"	50	Teklif İsteyiniz
SBR 100	1"	50	Teklif İsteyiniz
SBR 125	1-1/4"	50	Teklif İsteyiniz
SBR 150	1-1/2"	50	Teklif İsteyiniz
SBR 200	2"	50	Teklif İsteyiniz



### SIKMALI TİP EMT BORU BİRLEŞTİRME MUFLARI

SBM 050	1/2"	50	Teklif İsteyiniz
SBM 075	3/4"	50	Teklif İsteyiniz
SBM 100	1"	50	Teklif İsteyiniz
SBM 125	1-1/4"	50	Teklif İsteyiniz
SBM 150	1-1/2"	50	Teklif İsteyiniz
SBM 200	2"	50	Teklif İsteyiniz



### EMT TEK KULAK BORU KROŞELERİ

TKK 050	1/2"	50	Teklif İsteyiniz
TKK 075	3/4"	50	Teklif İsteyiniz
TKK 100	1"	50	Teklif İsteyiniz
TKK 125	1-1/4"	50	Teklif İsteyiniz
TKK 150	1-1/2"	50	Teklif İsteyiniz
TKK 200	2"	50	Teklif İsteyiniz



### EMT ÇİFT KULAK BORU KROŞELERİ

CKK 050	1/2"	50	Teklif İsteyiniz
CKK 075	3/4"	50	Teklif İsteyiniz
CKK 100	1"	50	Teklif İsteyiniz
CKK 125	1-1/4"	50	Teklif İsteyiniz
CKK 150	1-1/2"	50	Teklif İsteyiniz
CKK 200	2"	50	Teklif İsteyiniz



## EMT / IMC BORU & AKSESUARLARI

### EMT BORU ASMA KELEPÇESİ



Kod	Ölçü	Kutu Adedi	Birim Fiyatı Adet \$
BAK 050	1/2"	50	Teklif İsteyiniz
BAK 075	3/4"	50	Teklif İsteyiniz
BAK 100	1"	50	Teklif İsteyiniz
BAK 125	1-1/4"	50	Teklif İsteyiniz
BAK 150	1-1/2"	50	Teklif İsteyiniz
BAK 200	2"	50	Teklif İsteyiniz

### EMT BORU - 90°C DİRSEK



DE90-050	1/2"	50	Teklif İsteyiniz
DE90-075	3/4"	50	Teklif İsteyiniz
DE90-100	1"	50	Teklif İsteyiniz
DE90-125	1-1/4"	50	Teklif İsteyiniz
DE90-150	1-1/2"	50	Teklif İsteyiniz
DE90-200	2"	50	Teklif İsteyiniz

### IMC DIŞLI GALVANİZ BORULAR

ANSI C80.6 - 1242-1983



Kod	Ölçü	Dış Çap mm	Et Kalınlık	Ağırlık	Ambalaj	Rulo Boyu m	Birim Fiyatı mt. \$
GBI-050	1/2"	20,7	1,8	2,8	10	3,05	Teklif İsteyiniz
GBI-075	3/4"	26	1,9	3,8	5	3,05	Teklif İsteyiniz
GBI-100	1"	32,8	2,2	5,7	5	3,05	Teklif İsteyiniz
GBI-125	1-1/4"	41,6	2,3	7,3	3	3,05	Teklif İsteyiniz
GBI-150	1-1/2"	47,8	2,3	8,5	3	3,05	Teklif İsteyiniz
GBI-200	2"	59,9	2,4	11,4	3	3,05	Teklif İsteyiniz

### IMC PANO TİPİ RAKOR (HUB)



Kod	Ölçü	Kutu Adedi	Birim Fiyatı Adet \$
HB-050	1/2"	50	Teklif İsteyiniz
HB-075	3/4"	50	Teklif İsteyiniz
HB-100	1"	50	Teklif İsteyiniz
HB-125	1-1/4"	50	Teklif İsteyiniz
HB-150	1-1/2"	50	Teklif İsteyiniz
HB-200	2"	50	Teklif İsteyiniz

### MANŞON



MON-050	1/2"	25	Teklif İsteyiniz
MON-075	3/4"	25	Teklif İsteyiniz
MON-100	1"	25	Teklif İsteyiniz
MON-125	1-1/4"	10	Teklif İsteyiniz
MON-150	1-1/2"	10	Teklif İsteyiniz
MON-200	2"	10	Teklif İsteyiniz

### IMC TEK KULAK BORU KROŞELERİ



TKKI 050	1/2"	100	Teklif İsteyiniz
TKKI 075	3/4"	50	Teklif İsteyiniz
TKKI 100	1"	50	Teklif İsteyiniz
TKKI 125	1-1/4"	50	Teklif İsteyiniz
TKKI 150	1-1/2"	50	Teklif İsteyiniz
TKKI 200	2"	50	Teklif İsteyiniz

### IMC ÇİFT KULAK BORU KROŞELERİ



CKKI 050	1/2"	100	Teklif İsteyiniz
CKKI 075	3/4"	50	Teklif İsteyiniz
CKKI 100	1"	50	Teklif İsteyiniz
CKKI 125	1-1/4"	50	Teklif İsteyiniz
CKKI 150	1-1/2"	50	Teklif İsteyiniz
CKKI 200	2"	50	Teklif İsteyiniz

## EMT / IMC BORU & AKSESUARLARI

### IMC BORU - 90°C DİRSEK

Kod	Ölçü	Kutu Adedi	Birim Fiyatı Adet \$
DEI90-050	1/2"	25	Teklif İsteyiniz
DEI90-075	3/4"	25	Teklif İsteyiniz
DEI90-100	1"	25	Teklif İsteyiniz
DEI90-125	1-1/4"	10	Teklif İsteyiniz
DEI90-150	1-1/2"	10	Teklif İsteyiniz
DEI90-200	2"	10	Teklif İsteyiniz



### IMC METAL BUSHING

MCB-050	1/2"	100	Teklif İsteyiniz
MCB-075	3/4"	100	Teklif İsteyiniz
MCB-100	1"	50	Teklif İsteyiniz
MCB-125	1-1/4"	50	Teklif İsteyiniz
MCB-150	1-1/2"	50	Teklif İsteyiniz
MCB-200	2"	20	Teklif İsteyiniz
MCB-250	2 1/2"	5	Teklif İsteyiniz
MCB-300	3"	5	Teklif İsteyiniz
MCB-400	4"	5	Teklif İsteyiniz



### IMC PLASTİK BUSHING

PCB-050	1/2"	100	Teklif İsteyiniz
PCB-075	3/4"	100	Teklif İsteyiniz
PCB-100	1"	50	Teklif İsteyiniz
PCB-125	1-1/4"	50	Teklif İsteyiniz
PCB-150	1-1/2"	50	Teklif İsteyiniz
PCB-200	2"	20	Teklif İsteyiniz
PCB-250	2 1/2"	5	Teklif İsteyiniz
PCB-300	3"	5	Teklif İsteyiniz
PCB-400	4"	5	Teklif İsteyiniz



### KİLİTLEME SOMUNU

GCS-050	1/2"	100	Teklif İsteyiniz
GCS-075	3/4"	50	Teklif İsteyiniz
GCS-100	1"	50	Teklif İsteyiniz
GCS-125	1-1/4"	50	Teklif İsteyiniz
GCS-150	1-1/2"	50	Teklif İsteyiniz
GCS-200	2"	50	Teklif İsteyiniz
GCS-250	2 1/2"	5	Teklif İsteyiniz
GCS-300	3"	5	Teklif İsteyiniz
GCS-400	4"	5	Teklif İsteyiniz



### DAHİLİ TİP SAÇ BUAT 102 x 102 x 38

102x102x38

DB 01	1/2"	18x1/2-3x3/4	Teklif İsteyiniz
DB 02	3/4"	10x3/4-3x1/2	Teklif İsteyiniz
DB 03	1/2"-3/4"	11x1/2-6x3/4	Teklif İsteyiniz
DBK 01	Buat Kapağı		Teklif İsteyiniz



### DAHİLİ TİP SAÇ BUAT 102 x 102 x 54

102x102x54

DB 11	1/2"	18x1/2-3x3/4	Teklif İsteyiniz
DB 13	3/4"	10x3/4-3x1/2	Teklif İsteyiniz
DB 14	1/2"-3/4"	11x1/2-6x3/4	Teklif İsteyiniz
DBK 02	Buat Kapağı		Teklif İsteyiniz



### ALÜMİNYUM DÖKÜM KONDULET (LL-LB-LR-C)

KONI... 050	1/2"	50	Teklif İsteyiniz
KONI... 075	3/4"	50	Teklif İsteyiniz
KONI... 100	1"	50	Teklif İsteyiniz
KONI... 125	1-1/4"	50	Teklif İsteyiniz
KONI... 150	1-1/2"	50	Teklif İsteyiniz
KONI... 200	2"	50	Teklif İsteyiniz



## EMT / IMC BORU & AKSESUARLARI

### ALÜMİNYUM DÖKÜM KONDULET



Kod	Ölçü	Kutu Adedi	Birim Fiyatı Adet \$
KONI T 050	1/2"	100	Teklif İsteyiniz
KONI T 075	3/4"	50	Teklif İsteyiniz
KONI T 100	1"	50	Teklif İsteyiniz
KONI T 125	1-1/4"	50	Teklif İsteyiniz
KONI T 150	1-1/2"	50	Teklif İsteyiniz
KONI T 200	2"	50	Teklif İsteyiniz

### HARİCİ TİP SİRAL RAKORU-ERKEK



HR-050	1/2"	50	Teklif İsteyiniz
HR-075	3/4"	50	Teklif İsteyiniz
HR-100	1"	50	Teklif İsteyiniz
HR-125	1-1/4"	30	Teklif İsteyiniz
HR-150	1-1/2"	20	Teklif İsteyiniz
HR-200	2"	10	Teklif İsteyiniz
HR-250	2 1/2"	5	Teklif İsteyiniz
HR-300	3"	5	Teklif İsteyiniz
HR-400	4"	5	Teklif İsteyiniz

### HARİCİ TİP SİRAL RAKORU-DİŞİ



HRB-050	1/2"	50	Teklif İsteyiniz
HRB-075	3/4"	50	Teklif İsteyiniz
HRB-100	1"	50	Teklif İsteyiniz
HRB-125	1-1/4"	30	Teklif İsteyiniz
HRB-150	1-1/2"	20	Teklif İsteyiniz
HRB-200	2"	10	Teklif İsteyiniz
HRB-250	2 1/2"	5	Teklif İsteyiniz
HRB-300	3"	5	Teklif İsteyiniz
HRB-400	4"	5	Teklif İsteyiniz

### HARİCİ TİP 90° DİRSEK SİRAL RAKORU



HRD-050	1/2"	50	Teklif İsteyiniz
HRD-075	3/4"	50	Teklif İsteyiniz
HRD-100	1"	50	Teklif İsteyiniz
HRD-125	1-1/4"	30	Teklif İsteyiniz
HRD-150	1-1/2"	20	Teklif İsteyiniz
HRD-200	2"	10	Teklif İsteyiniz
HRD-250	2 1/2"	5	Teklif İsteyiniz
HRD-300	3"	5	Teklif İsteyiniz
HRD-400	4"	5	Teklif İsteyiniz

### HARİCİ TİP EMT-FLEX BAĞLANTI RAKORU-VİDALI TİP



VSEM 050	1/2"	50	Teklif İsteyiniz
VSEM 075	3/4"	50	Teklif İsteyiniz
VSEM 100	1"	50	Teklif İsteyiniz
VSEM 125	1-1/4"	30	Teklif İsteyiniz
VSEM 150	1-1/2"	20	Teklif İsteyiniz
VSEM 200	2"	10	Teklif İsteyiniz
VSEM 250	2 1/2"	5	Teklif İsteyiniz
VSEM 300	3"	5	Teklif İsteyiniz
VSEM 400	4"	5	Teklif İsteyiniz

### HARİCİ TİP IMC-FLEX BAĞLANTI RAKORU-SIKMALI TİP (DİŞSİZ)



HRFR 050	1/2"	50	Teklif İsteyiniz
HRFR 075	3/4"	50	Teklif İsteyiniz
HRFR 100	1"	50	Teklif İsteyiniz
HRFR 125	1-1/4"	30	Teklif İsteyiniz
HRFR 150	1-1/2"	20	Teklif İsteyiniz
HRFR 200	2"	10	Teklif İsteyiniz

### HARİCİ TİP FLEX-FLEX BAĞLANTI RAKORU-SIKMALI TİP



HRF 050	1/2"	50	Teklif İsteyiniz
HRF 075	3/4"	50	Teklif İsteyiniz
HRF 100	1"	50	Teklif İsteyiniz
HRF 125	1-1/4"	30	Teklif İsteyiniz
HRF 150	1-1/2"	20	Teklif İsteyiniz
HRF 200	2"	10	Teklif İsteyiniz





YÜKSÜKLER



SKP SIKMALI  
KABLO  
PABUÇLARI



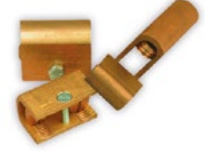





**\* Ürün gruplarımız için satış sorumlularımız ile irtibata geçiniz..**

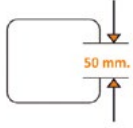

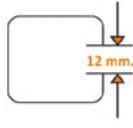
KABLO  
BAĞLARI &  
AKSESUARLARI

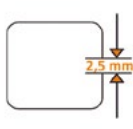
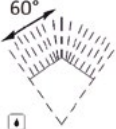
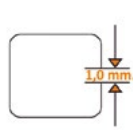
IP68 = IP AÇILIMI.....IP  
1.HANE.....6  
2.HANE.....8

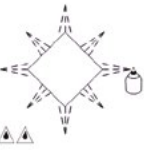
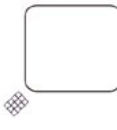
## KORUMA SINIFLARI (IP) TABLOSU

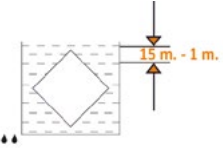
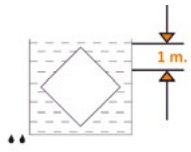
1. HANE	Katı Cisimlere Karşı Koruma Değerleri	2. HANE	Sıvı Maddelere Karşı Koruma Değerleri
0	Korumasız	0	Korumasız
1	 50 mm'den büyük katı cisimlere karşı korumasız	1	 Damlayan suya karşı korumalı
2	 12 mm'den büyük katı cisimlere karşı	2	 15 dereceye kadar damlayan su
3	 2,5 mm'den büyük katı cisimlere karşı	3	 60 dereceye kadar damlayan su
4	 1,0 mm'den büyük katı cisimlere karşı	4	 Sıçrayan suya karşı korumalı
5	 Toza karşı korumalı	5	 Su püskürtmesi
6	 Toz geçirmez	6	 Sıddetli deniz dalgası
		7	 15 m. - 1 m. Suya daldırma
		8	 1 m. Su altında bırakma

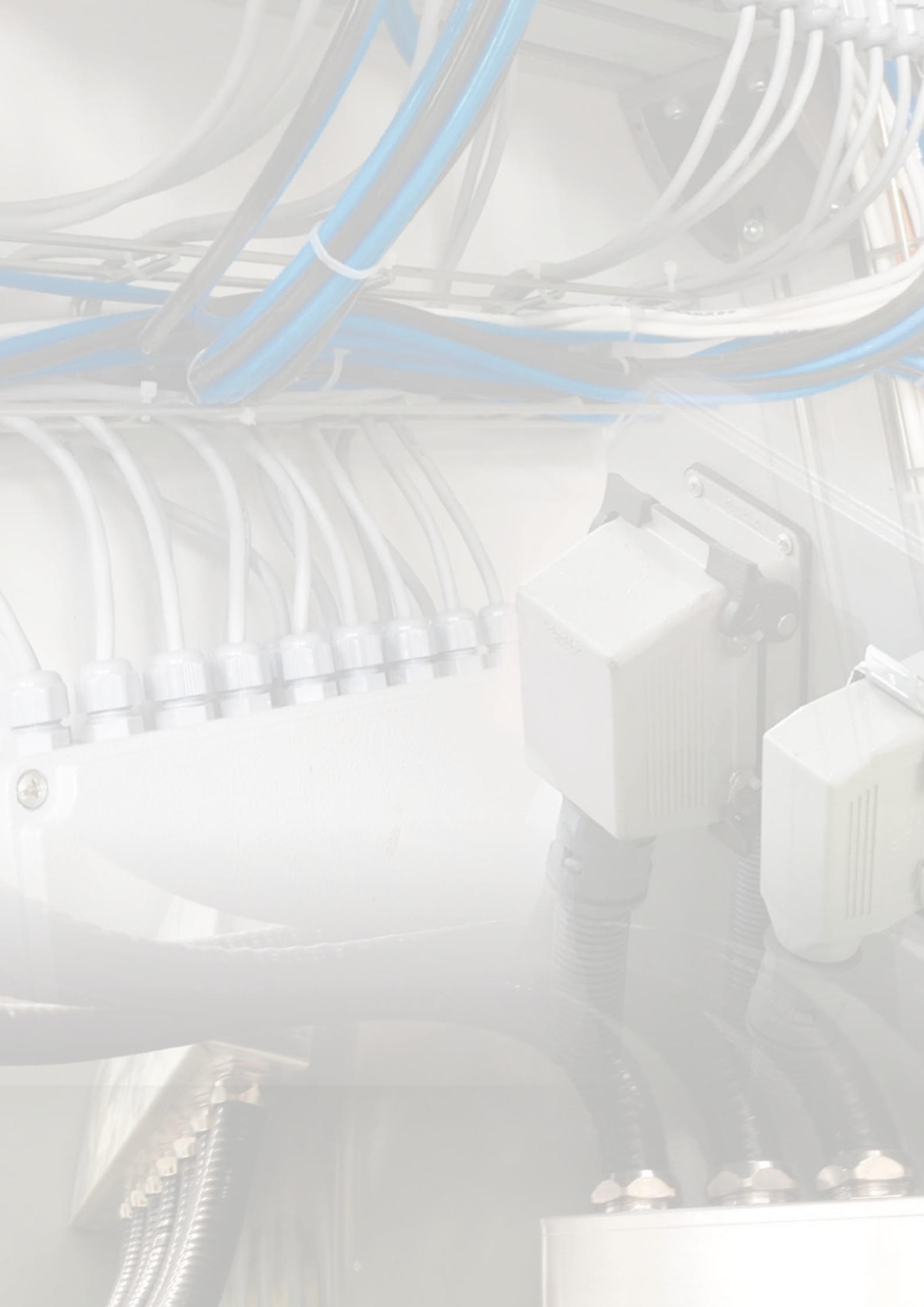

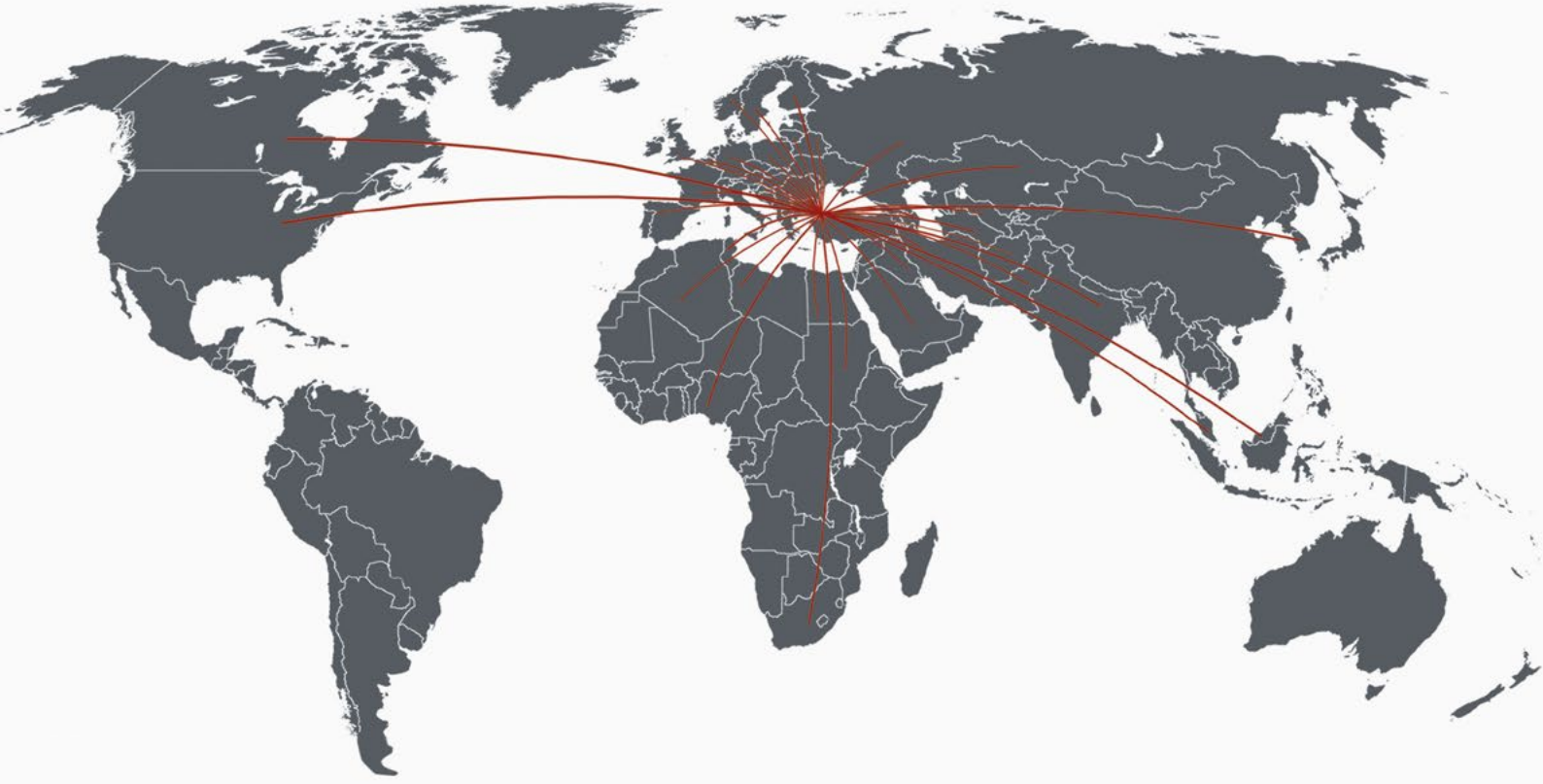

**Türkiye ve 7 Kıta 100 Farklı Ülkede**  
100'ün Üzerinde Satış Ağı

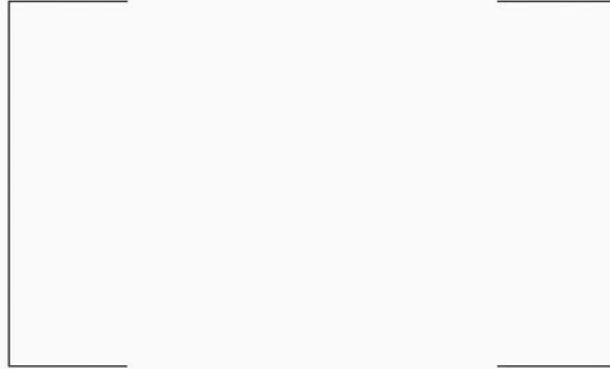

**ORTAC**<sup>®</sup>  
Cable Connection & Protection Systems

**Merkez:** Hadımköy Mah. İbni Sina Cad. No:9 Arnavutköy / İSTANBUL

**T:**+90 (212) 858-1900 **F:** +90 (212) 858-1959 **satis@ortac.com.tr**

**Şube:** Esenşehir Mahallesi Pırlanta Sk. No:60 Ümraniye / İSTANBUL



[www.ortac.com.tr](http://www.ortac.com.tr)